



# DVD RECORDER/ VIDEO CASSETTE RECORDER

## OWNER'S MANUAL

MODEL: RC700N

Before connecting, operating or adjusting this product,  
please read this owner's manual carefully and completely.



The Clear Choice In Digital Video™





**CAUTION: TO REDUCE THE RISK OF ELECTRIC SHOCK DO NOT REMOVE COVER (OR BACK) NO USER-SERVICEABLE PARTS INSIDE REFER SERVICING TO QUALIFIED SERVICE PERSONNEL.**



This lightning flash with arrowhead symbol within an equilateral triangle is intended to alert the user to the presence of uninsulated dangerous voltage within the product's enclosure that may be of sufficient magnitude to constitute a risk of electric shock to persons.



The exclamation point within an equilateral triangle is intended to alert the user to the presence of important operating and maintenance (servicing) instructions in the literature accompanying the product.

**WARNING: TO PREVENT FIRE OR ELECTRIC SHOCK HAZARD, DO NOT EXPOSE THIS PRODUCT TO RAIN OR MOISTURE.**

**WARNING:** Do not install this equipment in a confined space such as a book case or similar unit.

**CAUTION:**

Do not block any ventilation openings. Install in accordance with the manufacturer's instructions.

Slots and openings in the cabinet are provided for ventilation and to ensure reliable operation of the product and to protect it from over heating.

The openings should never be blocked by placing the product on a bed, sofa, rug or other similar surface. This product should not be placed in a built-in installation such as a bookcase or rack unless proper ventilation is provided or the manufacturer's instruction have been adhered to.

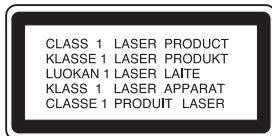

**CAUTION: CLASS 3B VISIBLE AND INVISIBLE LASER RADIATION WHEN OPEN AND INTERLOCKS DEFEATED. AVOID EXPOSURE TO THE BEAM.**

**CAUTION:**

This product employs a Laser System.

To ensure proper use of this product, please read this owner's manual carefully and retain it for future reference. Should the unit require maintenance, contact an authorized service center.

Performing controls, adjustments, or carrying out procedures other than those specified herein may result in hazardous radiation exposure.

To prevent direct exposure to laser beam, do not try to open the enclosure. Visible laser radiation when open. **DO NOT STARE INTO BEAM.**

**CAUTION:** The apparatus should not be exposed to water (dripping or splashing) and no objects filled with liquids, such as vases, should be placed on the apparatus.

**CAUTION concerning the Power Cord**

**Most appliances recommend they be placed upon a dedicated circuit;**

That is, a single outlet circuit which powers only that appliance and has no additional outlets or branch circuits. Check the specification page of this owner's manual to be certain. Do not overload wall outlets. Overloaded wall outlets, loose or damaged wall outlets, extension cords, frayed power cords, or damaged or cracked wire insulation are dangerous. Any of these conditions could result in electric shock or fire. Periodically examine the cord of your appliance, and if its appearance indicates damage or deterioration, unplug it, discontinue use of the appliance, and have the cord replaced with an exact replacement part by an authorized servicer.

Protect the power cord from physical or mechanical abuse, such as being twisted, kinked, pinched, closed in a door, or walked upon. Pay particular attention to plugs, wall outlets, and the point where the cord exits the appliance.

To disconnect power from the unit, unplug the unit from the outlet. When installing the product, ensure that the plug is easily accessible.

**FCC WARNING:** This equipment may generate or use radio frequency energy. Changes or modifications to this equipment may cause harmful interference unless the modifications are expressly approved in the instruction manual. The user could lose the authority to operate this equipment if an unauthorized change or modification is made.

**REGULATORY INFORMATION: FCC Part 15**

This equipment has been tested and found to comply with the limits for a Class B digital device, pursuant to Part 15 of the FCC Rules.

These limits are designed to provide reasonable protection against harmful interference in a residential installation. This equipment generates, uses and can radiate radio frequency energy and, if not installed and used in accordance with the instructions, may cause harmful interference to radio communications.

However, there is no guarantee that interference will not occur in a particular installation. If this equipment does cause harmful interference to radio or television reception, which can be determined by turning the equipment off and on, the user is encouraged to try to correct the interference by one or more of the following measures:

- Reorient or relocate the receiving antenna.
- Increase the separation between the equipment and receiver.
- Connect the equipment into an outlet on a circuit different from that to which the receiver is connected.
- Consult the dealer or an experienced radio/TV technician for help.

**FCC COMPLIANCE:** The responsible party for this product's compliance is:

LG Electronics U.S.A., Inc., 1000 Sylvan Avenue, Englewood Cliffs, NJ.  
Phone: 1-201-816-2000.

# IMPORTANT SAFETY INSTRUCTIONS

**CAUTION: PLEASE READ AND OBSERVE ALL WARNINGS AND INSTRUCTIONS IN THIS OWNER'S MANUAL. AND THOSE MARKED ON THE PRODUCT. RETAIN THIS BOOKLET FOR FUTURE REFERENCE.**

This product has been designed and manufactured to assure personal safety. Improper use can result in electric shock or fire hazard. The safeguards incorporated in this product will protect you if you observe the following procedures for installation, use, and servicing.

This product does not contain any parts that can be repaired by the user.

**DO NOT REMOVE THE CABINET COVER, OR YOU MAY BE EXPOSED TO DANGEROUS VOLTAGE. REFER SERVICING TO QUALIFIED SERVICE PERSONNEL ONLY.**

1. **Read these instructions.** - All these safety and operating instructions should be read before the product is operated.
2. **Keep these instructions.** - The safety, operating and use instructions should be retained for future reference.
3. **Heed all warnings.** - All warnings on the product and in the operating instructions should be adhered to.
4. **Follow all instructions.** - All operating and use instructions should be followed.
5. **Do not use this apparatus near water.** - For example: near a bath tub, wash bowl, kitchen sink, laundry tub, in a wet basement; or near a swimming pool; and other areas located near water.
6. **Clean only with dry cloth.** - Unplug this product from the wall outlet before cleaning. Do not use liquid cleaners.
7. **Do not block any ventilation openings. Install in accordance with the manufacturer's instructions.** - Slots and openings in the cabinet are provided for ventilation and to ensure reliable operation of the product and to protect it from over-heating. The openings should never be blocked by placing the product on a bed, sofa, rug or other similar surface. This product should not be placed in a built-in installation such as a bookcase or rack unless proper ventilation is provided or the manufacturer's instructions have been adhered to.
8. **Do not install near any heat sources such as radiators, heat registers, stoves, or other apparatus (including amplifiers) that produce heat.**
9. **Do not defeat the safety purpose of the polarized or grounding-type plug.** A polarized plug has two blades with one wider than the other. A grounding type plug has two blades and a third grounding prong. The wide blade or the third prong are provided for your safety. If the provided plug does not fit into your outlet, consult an electrician for replacement of the obsolete outlet.
10. **Protect the power cord from being walked on or pinched particularly at plugs, convenience receptacles, and the point where they exit from the apparatus.**
11. **Only use attachments/accessories specified by the manufacturer.**
12. **Use only with the cart, stand, tripod, bracket, or table specified by the manufacturer, or sold with the apparatus. When a cart is used, use caution when moving the cart/apparatus combination to avoid injury from tip-over.**



13. **Unplug this apparatus during lightning storms or when unused for long periods of time.**
14. **Refer all servicing to qualified service personnel. Servicing is required when the apparatus has been damaged in any way, such as power-supply cord or plug is damaged, liquid has been spilled or objects have fallen into the apparatus, the apparatus has been exposed to rain or moisture, does not operate normally, or has been dropped.**

## INTRODUCTION

|                                  |    |
|----------------------------------|----|
| About the $\odot$ Symbol Display | 5  |
| Symbol Used in this Manual       | 5  |
| Notes on Discs                   | 5  |
| Moisture Condensation            | 5  |
| About the Remote Control         | 5  |
| Recordable and Playable Discs    | 6  |
| Recommended recordable DVD discs | 6  |
| Playable Discs                   | 7  |
| Regional Code                    | 7  |
| Restrictions on video recording  | 8  |
| What is 'CPRM'?                  | 8  |
| Copyright                        | 8  |
| Notice for Progressive Scan Use  | 8  |
| Front Panel                      | 9  |
| Remote Control                   | 10 |
| Rear Panel                       | 11 |

## HOOKUP AND SETTINGS

|  |       |
|--|-------|
| Connections to your TV                   | 12-13 |
| Connection to an Amplifier               | 14    |
| Accessory Audio/Video (A/V)              |       |
| Connections to Recorder                  | 15    |
| Connecting a Digital Camcorder           | 15    |
| Connecting the IR control cable          | 16    |
| Initial Setup Wizard                     | 17    |
| Using the Home Menu                      | 17    |
| Initial Settings                         | 18    |
| General Settings                         | 18    |
| Language Settings                        | 19    |
| Audio Settings                           | 19    |
| Lock (Parental Control) Settings         | 20    |
| Recording Settings                       | 21-22 |
| Disc Settings                            | 23    |
| General Explanation of On-Screen Display | 24    |

## PLAYBACK

|                                      |       |
|--------------------------------------|-------|
| Playing a Tape                       | 25    |
| Playing a DVD                        | 25    |
| VCR Playback Options                 | 26    |
| DVD Playback Features                | 27-28 |
| Special Playback Options             | 29    |
| Playing an Audio CD or MP3/WMA files | 30    |
| Viewing a JPEG files                 | 31-32 |

## RECORDING

|                                    |    |
|------------------------------------|----|
| About DVD recording                | 33 |
| Notes for recording                | 33 |
| Recording time and picture quality | 33 |
| Recording from External Components | 34 |
| Instant Timer Recording            | 34 |
| Simultaneous Play and Record       | 34 |

|                                   |    |
|-----------------------------------|----|
| Timer Recording                   | 35 |
| AV1 Timer Recording using Set-Top |    |
| Channel option                    | 36 |
| Timer Recording Troubleshooting   | 37 |
| Playing while you are recording   | 37 |
| Dubbing from DVD to VCR           | 38 |
| Dubbing from VCR to DVD           | 38 |
| Recording from DV Input           | 39 |

## EDITING

|   |    |
|---|----|
| Title List and Chapter List Menu Overview                           | 40 |
| VR Mode: Original and Playlist Editing                              | 41 |
| Adding Chapter Markers  | 41 |
| Changing the Title Thumbnails                                       | 41 |
| Making a New Playlist   | 42 |
| Adding Additional Title/Chapters to the Playlist                    | 42 |
| Deleting an Original or Playlist Title/Chapter                      | 43 |
| Deleting a Part   | 43 |
| Naming a Title  | 44 |
| Time Search   | 44 |
| Moving a Playlist Chapter   | 45 |
| Hide a Chapter/Title  | 45 |
| Protect a Title   | 45 |
| Divide One Title Into Two   | 46 |
| Combining Two Chapters Into One                                     | 46 |
| Overwriting Recording   | 47 |
| Viewing Title List menu displayed on other DVD Recorders or Players | 47 |
| Playing Your Recordings on Other DVD Players (Finalizing a Disc)    | 47 |

## REFERENCE

|  |            |
|--|------------|
| Controlling Your TV with the Supplied Multi-brand Remote Control | 48         |
| Language Code List   | 49         |
| Area Codes List  | 49         |
| Troubleshooting  | 50-52      |
| Resetting the Recorder   | 52         |
| Specifications   | 53-54      |
| Warranty   | Rear Cover |

# Introduction

To ensure proper use of this product, please read this owner's manual carefully and retain for future reference.

## About the Symbol Display

"" may appear on your TV display during operation and indicates that the function is not permitted by this unit or specific media.

## Symbol Used in this Manual

**Note:** Indicates special notes and operating features.

**Tip:** Indicates tips and hints for making the task easier.

A section whose title has one of the following symbols are applicable only to those discs represented by the symbol.

- DVD ALL** All DVD discs listed below.
- RW<sub>VR</sub>** DVD-RW with VR recording mode
- RW<sub>Video</sub>** DVD-RW with Video recording mode
- RAM** DVD-RAM disc
- +RW** DVD+RW disc
- R** DVD-R disc
- +R** DVD+R (DL) disc
- DVD** DVD-Video disc
- ACD** Audio CDs
- MP3** MP3 files
- WMA** WMA files
- JPEG** JPEG files
- VCR** VHS Tape

## Notes on Discs

### Handling Discs

Do not touch the playback side of the disc. Hold the disc by the edges so that fingerprints do not get on the surface. Never stick paper or tape on the disc.



### Storing Discs

After playing, store the disc in its case. Do not expose the disc to direct sunlight or sources of heat and never leave it in a parked car exposed to direct sunlight.

### Cleaning Discs

Fingerprints and dust on the disc can cause poor picture quality and sound distortion. Before playing, clean the disc with a clean cloth. Wipe the disc from the center out.

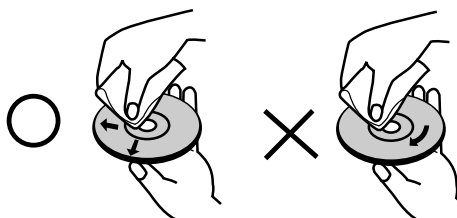

Do not use strong solvents such as alcohol, benzene, thinner, commercially available cleaners, or anti-static spray intended for older vinyl records.

### Moisture Condensation

Never operate this product immediately after moving it from a cold location to a warm location. Leave it for two or three hours without operating it. If you use this product in such a situation, it may damage discs/tapes and internal parts.

## About the Remote Control

### Operation Range

Point the Remote Control at the Remote Sensor and press the buttons.

**Distance:** About 23 ft (7 m) from the front of the Remote Sensor.

**Angle:** About 30° in each direction of the front of the Remote Sensor.

## Battery installation

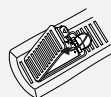

Detach the battery cover on the rear of the Remote Control, and insert two (R03/AAA) size batteries with ⊕ and ⊖ aligned correctly.



Do not mix old and new batteries and never mix different types of batteries such as standard, alkaline, etc.

## Recordable and Playable Discs



### DVD-RW (DVD - ReWritable)

- DVD-RW discs can be formatted for VR mode recording or Video mode recording.
- These Discs can be recorded on repeatedly. Recordings can be erased, then you can record again on the same Disc.

[VR mode]

- Recordings can be extensively edited
- Playable only on VR mode compatible players (after finalization)

[Video mode]

- Playable on regular DVD players (after finalization)
- Limited editing features



### DVD-R (DVD - Recordable)

- These Discs can be recorded only once. After you finalize a DVD-R, you cannot record on it or edit it.
- DVD-R discs can be only formatted to Video mode.
- Playable on regular DVD players (after finalization)
- Limited editing features



### DVD-RAM (DVD - Random Access Memory)

- DVD-RAM discs can be formatted for VR mode recording.
- These Discs can be recorded on repeatedly. Recordings can be erased, then you can record again on the same Disc.
- Playable on DVD-RAM compatible players.
- Recordings can be extensively edited.
- Only DVD-RAM standard Version 2.0, 2.1 and 2.2 discs can be used in this unit.
- You cannot use the cartridge-type DVD-RAM disc in this unit.



### DVD+RW (DVD + ReWritable)

- These Discs can be recorded on repeatedly. Recordings can be erased, then you can record again on the same Disc.
- Playable on DVD+RW compatible players (automatic finalization)
- The edited contents are playable on DVD+RW compatible players only after finalization.
- Recordings can be edited.



### DVD+R (DVD + Recordable)

- These Discs can be recorded only once. After you finalize a DVD+R, you cannot record on it or edit it any more.
- Playable on DVD+R compatible players (after finalization)
- Any edited contents are not be compatible on DVD+R compatible players. (Hide, chapter combine, added chapter mark, etc.)
- Limited title/chapter editing features.



### DVD+R DL (DVD + Recordable; Double Layer)

- These Discs can be recorded only once. After you finalize a DVD+R DL, you cannot record on it or edit it any more.
- Storage space is nearly doubled with double layer DVD+R media, allowing consumers to record up to 8.5GB of video on a single DVD+R DL disc.
- Playable on DVD+R compatible players (after finalization)
- Any edited contents are not compatible on DVD+R DL compatible players. (Hide, chapter combine, added chapter mark, etc.)
- Limited title/chapter editing features.

## Recommended recordable DVD discs

| DVD-R                | DVD+R                | DVD-RW          | DVD+RW           | DVD+R DL          | DVD-RAM         |
|----------------------|----------------------|-----------------|------------------|-------------------|-----------------|
| Mitsubishi (8x, 16x) | Mitsubishi (8x, 16x) | Mitsubishi (4x) | Mitsubishi (4x)  | Mitsubishi (2.4x) | Fujifilm (2x)   |
| That's (8x, 16x)     | Ricoh (8x, 16x)      | Verbatim (4x)   | SONY (2.4x)      | Maxell (2.4x)     | Mitsubishi (3x) |
| SONY (16x)           | SONY (16x)           | JVC (4x)        | Verbatim (2.4x)  | -                 | -               |
| -                    | -                    | Victor (4x)     | Ricoh (2.4X, 4x) | -                 | -               |
| -                    | -                    | Maxell (4x)     | -                | -                 | -               |

## Playable Discs



### DVD (8 cm / 12 cm disc)

Discs such as movies that can be purchased or rented



### Audio CD (8 cm / 12 cm disc)

Music CDs or CD-Rs/CD-RWs in music CD format that can be purchased



### CD-R/CD-RW (8 cm / 12 cm disc)

CD-R/CD-RW discs that contain audio titles, MP3, WMA or JPEG files.

#### Notes:

- Depending on the conditions of the recording equipment or the CD-R/RW (or DVD±R/RW) disc itself, some CD-R/RW (or DVD±R/RW) discs cannot be played on the unit.
- Do not attach any seal or label to either side (the labeled side or the recorded side) of a disc.
- Do not use irregularly shaped CDs (e.g., heart-shaped or octagonal). Doing so may result in malfunctions.
- Depending on the recording software & the finalization, some recorded discs (CD-R/RW or DVD±R/RW) may not be playable.
- DVD-R/RW, DVD+R/RW and CD-R/RW discs recorded using a personal computer or a DVD or CD Recorder may not play if the disc is damaged or dirty, or if there is dirt or condensation on the Recorder's lens.
- If you record a disc using a personal computer, even if it is recorded in a compatible format, there are cases in which it may not play because of the settings of the application software used to create the disc. (Check with the software publisher for more detailed information.)
- This recorder requires discs and recordings to meet certain technical standards in order to achieve optimal playback quality. Pre-recorded DVDs are automatically set to these standards. There are many different types of recordable disc formats (including CD-R containing MP3 or WMA files) and these require certain pre-existing conditions (see above) to ensure compatible playback.
- Customers should note that permission is required in order to download MP3 / WMA files and music from the Internet. Our company has no right to grant such permission. Permission should always be sought from the copyright owner.

## Regional Code

This unit has a regional code printed on the rear of the unit. This unit can play only DVD discs labeled same as the rear of the unit or "ALL".

#### Notes on Regional Codes

- Most DVD discs have a globe with one or more numbers in it clearly visible on the cover. This number must match your unit's regional code or the disc cannot play.
- If you try to play a DVD with a different regional code from the unit, the message "Incorrect region code. Can't play back" appears on the TV screen.



#### What is SIMPLINK?

Some functions of this unit are controlled by TV's remote control when this unit and LG TV with SIMPLINK are connected through HDMI connection.

- Controllable functions by LG TV's remote control; Play, Pause, Scan, Skip, Stop, Power Off, etc.
- Refer to the TV owner's manual for the details of SIMPLINK function.
- LG TV with SIMPLINK function has the logo as shown above.

## Restrictions on video recording

- You cannot record copy-protected video using this recorder. Copy-protected video includes DVD-Video discs and some satellite broadcasts. If copy-protected material is encountered during a recording, recording will pause or stop automatically and an error message will be displayed on-screen.
- Video that is 'copy-once only' can only be recorded using a DVD-RW disc in VR mode or DVD-RAM disc with CPRM (see below).

## What is 'CPRM'?

CPRM is a copy protection system (with scramble system) only allowing the recording of 'copy once' broadcast programs. CPRM stands for Content Protection for Recordable Media.

This Recorder is CPRM compatible, which means that you can record copy-once broadcast programs, but you cannot then make a copy of those recordings. CPRM recordings can only be made on DVD-RW discs formatted in VR mode or DVD-RAM discs, and CPRM recordings can only be played on players that are specifically compatible with CPRM.

## Copyright

- Recording equipment should be used only for lawful copying and you are advised to check carefully what is lawful copying in the area in which you are making a copy. Copying of copyright material such as films or music is unlawful unless permitted by a legal exception or consented to by the rights owner.
- This product incorporates copyright protection technology that is protected by method claims of certain U.S. patents and other intellectual property rights owned by Macrovision Corporation and other rights owners. Use of this copyright protection technology must be authorized by Macrovision Corporation, and is intended for home and other limited viewing uses only, unless otherwise authorized by Macrovision corporation. Reverse engineering or disassembly is prohibited.





## Notice for Progressive Scan Use

CONSUMERS SHOULD NOTE THAT NOT ALL HIGH DEFINITION TELEVISION SETS ARE FULLY COMPATIBLE WITH THIS PRODUCT AND MAY CAUSE ARTIFACTS TO BE DISPLAYED IN THE PICTURE. IN CASE OF 525 PROGRESSIVE SCAN PICTURE PROBLEMS, IT IS RECOMMENDED THAT THE USER SWITCH THE CONNECTION TO THE 'STANDARD DEFINITION' OUTPUT. IF THERE ARE QUESTIONS REGARDING YOUR TV SET COMPATIBILITY WITH THIS MODEL 525p DVD+VCR RECORDER, PLEASE CONTACT OUR CUSTOMER SERVICE CENTER.

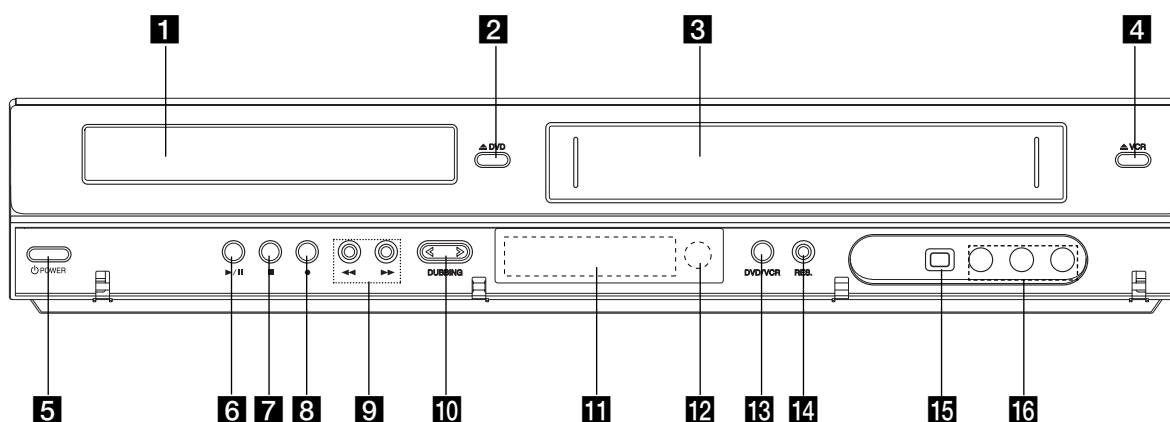

## Front Panel



- 1 Disc Tray (DVD deck)**  
Insert a disc here.
- 2 ▲ DVD**  
Opens or closes the disc tray.
- 3 Cassette Compartment (VCR deck)**  
Insert a video cassette here.
- 4 ▲ VCR**  
Ejects the tape in the VCR deck.
- 5 ⏻ POWER**  
Switches the Recorder ON and OFF.
- 6 ▶ / ⏸ (PLAY / PAUSE)**  
Starts playback.  
Pause playback or recording temporarily, press again to exit pause mode.
- 7 ■ (STOP)**  
Stops playback
- 8 ● (REC)**  
Starts recording.  
Press repeatedly to set the recording time.
- 9 BACKWARD / FORWARD (◀◀/▶▶)**  
- DVD: Search backward or forward.  
- VCR: Rewinds/Advances the tape during the STOP mode, for fast reverse/forward picture search.
- 10 DUBBING**  
Press to copy DVD to VCR (or VCR to DVD).  
Lights when the Recorder is dubbing.
- 11 Display window**  
Shows the current status of the Recorder.  
 Lights when a disc is in the DVD deck.  
**DVD** The DVD deck is selected.
- ▶ ◀** Lights when the Recorder is in playing mode or flashes when search mode.  
**VCR** The VCR deck is selected.
-  Indicates when the recorder is in timer recording or a timer recording is programmed.
-  A VHS tape is inserted in the VCR deck.
- REC** The Recorder is recording.
- PM** Indicates PM time. (AM is not displayed.)
-  Indicates total playing time, elapsed time, remaining time or current deck status (Playback, Pause, etc).
- 12 Remote Sensor**  
Point the recorder Remote Control here.
- 13 DVD/VCR**  
Toggles control between the DVD deck and the VCR deck.
- 14 RES.**  
Sets the output resolution for HDMI and COMPONENT OUTPUT jacks.  
- HDMI: 1080i, 720p, 480p, 480i  
- COMPONENT: 480p, 480i
- 15 DV IN**  
Connect the DV output of a digital camcorder.
- 16 AV IN 2 (VIDEO /AUDIO (Left/Right))**  
Connect the audio/video output of an external source (Audio system, TV/ Monitor, VCR, Camcorder, etc.).

## Remote Control

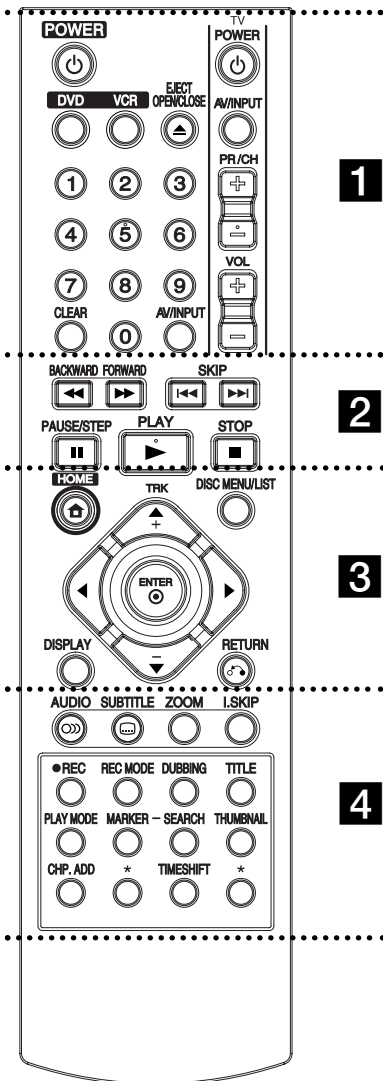

..... **1** .....

### POWER (⏻)

Turns Recorder ON and OFF.

### DVD

Select the Recorder's function mode to DVD.

### VCR

Select the Recorder's function mode to VCR.

### EJECT, OPEN/CLOSE (⏏)

- Opens and closes the disc tray.  
- Ejects the tape in the VCR deck.

### 0-9 numerical buttons

Selects numbered options in a menu.

**1**

### CLEAR

Removes a mark on the Marker Search menu.

### AV/INPUT

Changes the input to use for recording (AV1, AV2, or DV IN).

### TV Control Buttons

See page 48.

..... **2** .....

**2**

### BACKWARD / FORWARD

(◀▶)

- DVD: Search backward or forward.  
- VCR: Rewinds/Advances the tape during the STOP mode, for fast reverse/forward picture search.

**3**

### SKIP (◀◀ / ▶▶)

Go to next chapter or track. Returns to beginning of current chapter or track or go to previous chapter or track.

### PAUSE/STEP (⏸)

Pause playback or recording temporarily.  
Press repeatedly for frame-by-frame playback.

**4**

### PLAY (▶)

Starts playback.

### STOP (■)

Stops playback or recording.

..... **3** .....

### HOME

Accesses or removes the HOME menu.

### TRK (+/-)

Adjusts manually the tape's picture onscreen.

### DISC MENU/LIST

Accesses menu on a DVD disc, Title List or Playlist menu.

### ◀▶ ▲ ▼ (left/right/up/down)

Selects menu options.

### ENTER (⊙)

Confirms menu selections.

### DISPLAY

Accesses On-Screen Display.  
Displays information of current status.

### RETURN (↵)

Removes the menu.

..... **4** .....

### AUDIO

Selects an audio language or an audio channel.

### SUBTITLE

Selects a subtitle language.

### ZOOM

Enlarges DVD video image.

### I.SKIP (INSTANT SKIP)

Skips 30 seconds forward during playback.

### ● REC

Starts recording. Press repeatedly to set the recording time.

### REC MODE

Selects the recording mode:  
- DVD: XP, SP, LP, EP or MLP.  
- VCR: SP or SLP.

### DUBBING

Press to copy DVD to VCR (or VCR to DVD).

### TITLE

Displays the disc's Title menu, if available.

### PLAY MODE

Selects play mode.

### MARKER

Marks any point during playback.

### SEARCH

Displays Marker Search menu.

### THUMBNAIL

Selects a thumbnail picture for the current title for use in the Title List menu.

### CHP. ADD

Inserts a chapter marker when playing/recording.

### TIME SHIFT

To play the title being recorded and also currently being recorded appears as PIP.

\*

This button is not available.

## Rear Panel

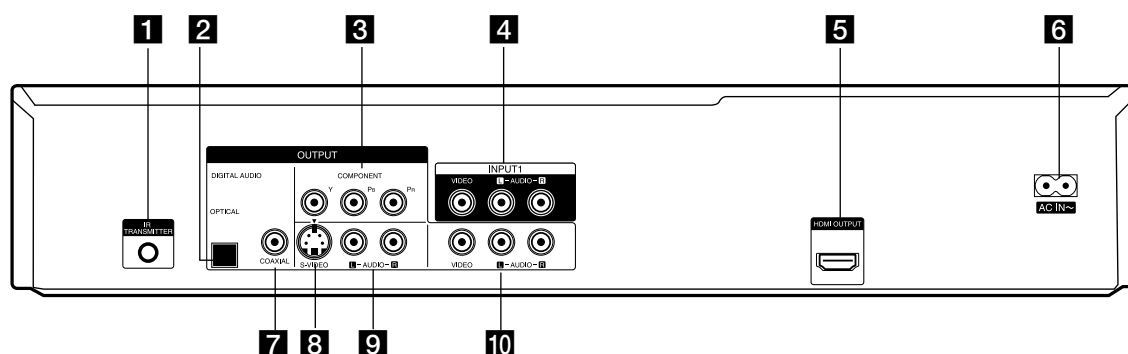

- |   |   |
|---|---|
| <p><b>1 IR TRANSMITTER</b><br/>Connect the IR control cable (if used).</p> <p><b>2 OPTICAL (DIGITAL AUDIO OUTPUT)</b><br/>Connect to digital (optical) audio equipment.</p> <p><b>3 COMPONENT OUTPUT (Y P<sub>B</sub> P<sub>R</sub>)</b><br/>Connect to a TV with Y P<sub>B</sub> P<sub>R</sub> inputs.</p> <p><b>4 INPUT 1 (VIDEO/AUDIO (Left/Right))</b><br/>Connect the audio/video output of an external source (Audio system, TV/Monitor, VCR, Camcorder).</p> <p><b>5 HDMI OUTPUT</b><br/>HDMI output providing a high quality interface for digital audio and video.</p> <p><b>6 AC Power Cord</b><br/>Plug into the power source.</p> | <p><b>7 COAXIAL (DIGITAL AUDIO OUTPUT)</b><br/>Connect to digital (coaxial) audio equipment.</p> <p><b>8 S-VIDEO OUTPUT</b><br/>Connect to a S-Video Input on TV.</p> <p><b>9 AUDIO OUTPUT (Left/Right)</b><br/>Connect to a TV or other equipment with audio inputs.</p> <p><b>10 VIDEO/AUDIO OUTPUT (Left/Right)</b><br/>Connect to a TV with video and audio inputs.</p> |
|---|---|

### **Caution:**

Do not touch the inner pins of the jacks on the rear panel.  
Electrostatic discharge may cause permanent damage to the unit.

# Hookup and Settings

Depending on your TV and other equipment there are various ways you can connect the recorder. Please refer to the manuals of your TV, VCR, Stereo System or other devices as necessary for additional connection information.

## Notes:

- Make sure the Recorder is connected directly to the TV and tune the TV to the correct video input channel.
- Do not connect the Recorder's AUDIO OUTPUT jack to the phono in jack (record deck) of your audio system.
- Do not connect the Recorder via another VCR. The DVD image could be distorted by the copy protection system.
- The picture and sound of a nearby TV, VCR, or radio may be distorted during playback. Position the units away from each other or turn off the unit after removing the disc.

## Connections to your TV

Make one of the following connections, depending on the capabilities of your TV.

### Video connection

Connect the VIDEO OUTPUT jack on the Recorder to the video in jack on the TV using the video cable supplied (V).

### Note:

If you use this connection, set the TV's source selector to VIDEO.

### S-Video connection

Connect the S-VIDEO OUTPUT jack on the Recorder to the S-Video in jack on the TV using the optional S-Video cable (S).

### Component Video connection

If your television is a high-definition or "digital ready" television, you may take advantage of the Recorder's progressive scan output for the highest video resolution possible.

Connect the COMPONENT OUTPUT jacks on the Recorder to the corresponding in jacks on the TV using an optional Y P<sub>B</sub> P<sub>R</sub> cable (C).

## Notes:

- Set the resolution to 480p using RES. button on the front panel for progressive signal.
- Progressive Scan does not work with the Video or S-Video connections.
- If your TV does not accept the Progressive Scan format, the picture will appear scrambled.
- If the resolution is set to 720p or 1080i, the VIDEO OUTPUT, S-VIDEO OUTPUT and COMPONENT OUTPUT connections are not available.

## Audio connection

Connect the Left and Right AUDIO OUTPUT jacks on the Recorder to the audio left/right in jacks on the TV using the supplied audio cables (A1 or A2).

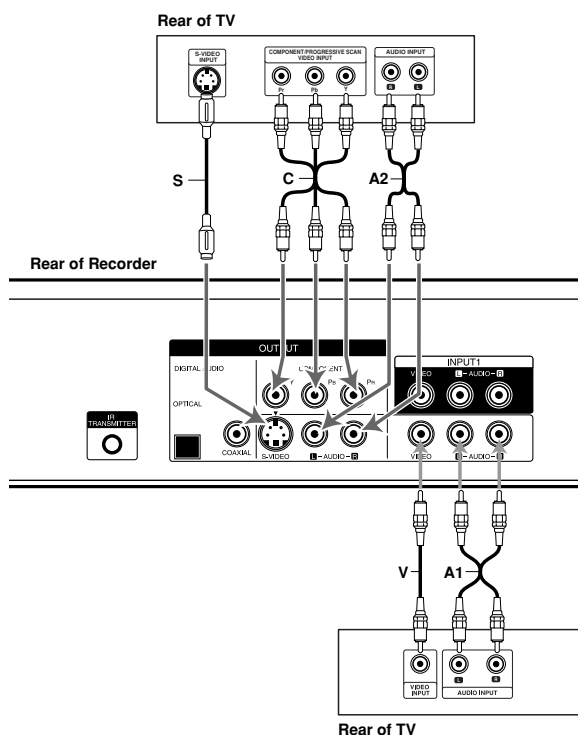

## HDMI connection

If you have a HDMI TV or monitor, you can connect it to this recorder using a HDMI cable.

1. Connect the HDMI OUTPUT jack on the recorder to the HDMI INPUT jack on a HDMI compatible TV or monitor (H).
2. Set the TV's source to HDMI (refer to TV's Owner's manual).

### Notes:

- If your TV is NOT capable of handling 96 kHz sampling frequency, set the [Sampling Freq.] option to [48 kHz] on the setup menu (See page 19). When this choice is made, this unit will automatically convert any 96 kHz signals to 48 kHz so your system can decode them.
- If your TV is not equipped with Dolby Digital and MPEG decoder, set the [Dolby Digital] and [MPEG] options to [PCM] on the setup menu (See page 19).
- If your TV is not equipped with DTS decoder, set the [DTS] options to [OFF] on the setup menu (See page 19). To enjoy DTS multi channel surround, you must connect this recorder to a DTS compatible receiver via one of this recorder's digital audio outputs.
- The arrow on the cable connector body should face up for correct alignment with the connector on the recorder.

(Type A)

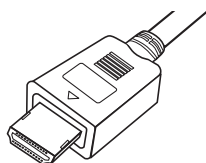

- If there is noise or lines on the screen, please check the HDMI cable.
- Not all HDCP-compatible

### Tip:

When you use HDMI connection, you can change the resolution (480i, 480p, 720p, or 1080i) for the HDMI output using RES. button on the front panel.

### Caution:

- Changing the resolution when the recorder is connected with HDMI connector may result in malfunctions. To solve the problem, turn off the recorder and then turn it on again.
- If your TV does not accept your resolution setting, abnormal picture appears on the screen. Please read TV's owner's manual then set the resolution that your TV can accept.

## About HDMI

HDMI (High Definition Multimedia Interface) supports both video and audio on a single digital connection for use with DVD Players, Set-Top Boxes, and other AV devices.

HDMI was developed to provide the technologies of HDCP (High Definition Contents Protection). HDCP is used to protect digital content transmitted and received.

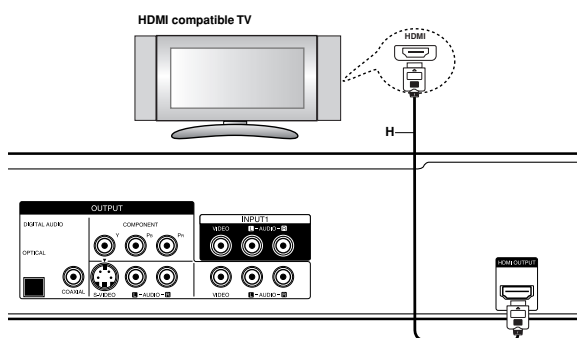

HDMI has the capability to support standard, enhanced, or high-definition video plus standard to multi-channel surround-sound audio, HDMI features include uncompressed digital video, a bandwidth of up to 5 gigabytes per second, one connector (instead of several cables and connectors), and communication between the AV source and AV devices such as DTVs.

*HDMI, the HDMI logo and High-Definition Multimedia Interface are trademarks or registered trademarks of HDMI licensing LLC.*

### Additional Information for HDMI

- When you connect a HDMI or DVI compatible device make sure of the following:
  - Try switching off the HDMI/DVI device and this recorder. Next, switch on the HDMI/DVI device and leave it for around 30 seconds, then switch on this recorder.
  - The connected device's video input is set correctly for this unit.
  - The connected device is compatible with 720(1440)x480i, 720x480p, 1280x720p, or 1920x1080i video input.
- Not all HDCP-compatible DVI devices will work with this recorder.
  - It's impossible copy protected-DVD title's playback in non-HDCP devices.
- For best performance, directly connect the HDMI output to an HDMI input on your TV. If connecting to some device other than a TV or monitor, such as a home theater receiver with an HDMI input, check the following to make sure the HDMI signal will be received correctly:
  - Check the operating instructions of the connected device to make sure that the HDMI input of the device complies with HDMI-HDCP specifications.
  - Check that the HDMI setup menu of any non-display device is set to "pass-through" so that HDMI signals received are not changed in any way (such as changing the video or audio format).

## Connection to an Amplifier

### Connecting to an amplifier equipped with two channel analog stereo or Dolby Pro Logic II/Pro Logic

Connect the Left and Right AUDIO OUTPUT jacks on the Recorder to the audio left and right in jacks on your amplifier, receiver, or stereo system using the audio cables (A) supplied.

### Connecting to an amplifier equipped with two channel digital stereo (PCM) or to an Audio/Video receiver equipped with a multi-channel decoder (Dolby Digital™, MPEG 2, or DTS)

1. Connect one of the Recorder's DIGITAL AUDIO OUTPUT jacks (OPTICAL O, COAXIAL X) to the corresponding in jack on your amplifier. Use an optional digital (optical O, coaxial X) audio cable.
2. You will need to activate the Recorder's digital output. (See [Audio Settings] on page 19).

### Digital Multi-channel sound

A digital multi-channel connection provides the best sound quality. For this you need a multi-channel Audio/Video receiver that supports one or more of the audio formats supported by your Recorder (MPEG 2, Dolby Digital and DTS). Check the receiver manual and the logos on the front of the receiver.

### Caution:

Due to the DTS Licensing agreement, the digital output will be in DTS digital out when DTS audio stream is selected.

### Notes:

- If the audio format of the digital output does not match the capabilities of your receiver, the receiver will produce a strong, distorted sound or no sound at all.
- Six Channel Digital Surround Sound via digital connection can only be obtained if your receiver is equipped with a Digital Multi-channel decoder.
- To see the audio format of the current DVD in the on-screen display, press AUDIO.
- This Recorder does not perform internal (2 channel) decoding of a DTS sound track. To enjoy DTS multi channel surround, you must connect this Recorder to a DTS compatible receiver via one of this Recorder's digital audio outputs.
- While viewing a digital channel, the 2 channel stereo audio is only output through the audio output jacks.

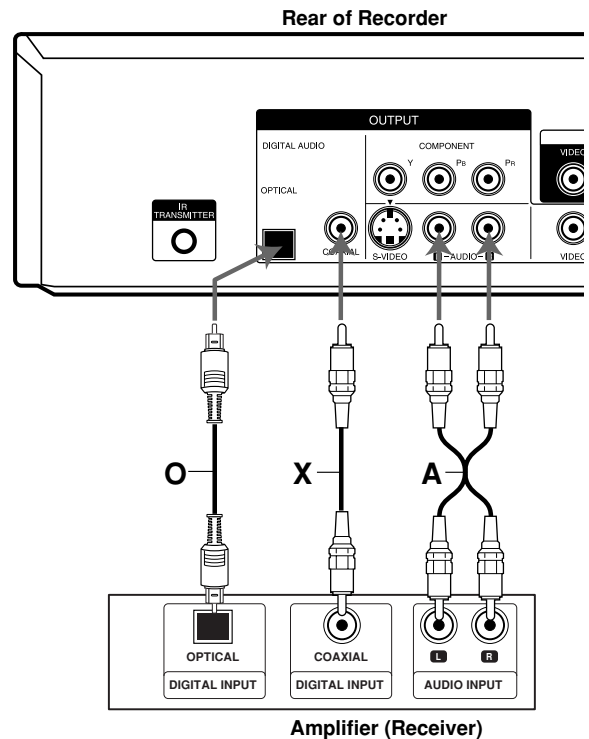

Manufactured under license from Dolby Laboratories. "Dolby", "Pro Logic", and the double-D symbol are trademarks of Dolby Laboratories.

DTS and DTS Digital Out are trademarks of Digital Theater Systems, Inc.

## Accessory Audio/Video (A/V) Connections to Recorder

Connect the INPUT 1 or AV IN 2 jacks on the Recorder to the audio/video out jacks on your accessory component, using the optional audio/video cables. (Refer to page 34 for [Recording from External Components].)

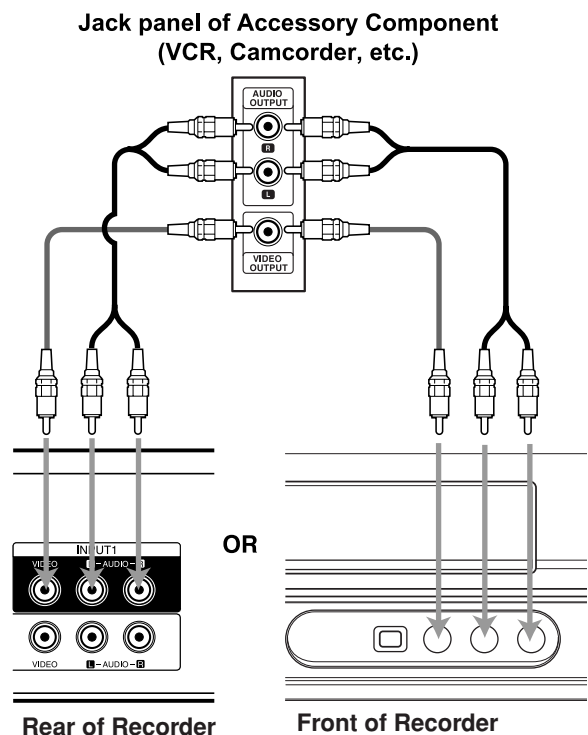

## Connecting a Digital Camcorder

Use a DV cable (not supplied) to connect the DV in/out jack of your DV Digital Camcorder to the front panel DV IN jack of this Recorder.

**Notes:**

- This jack is for connection to DV equipment only. It is not compatible with digital satellite tuners or D-VHS video decks.
- Disconnecting the DV cable while recording a contents of the connected digital camcorder may result in malfunction.

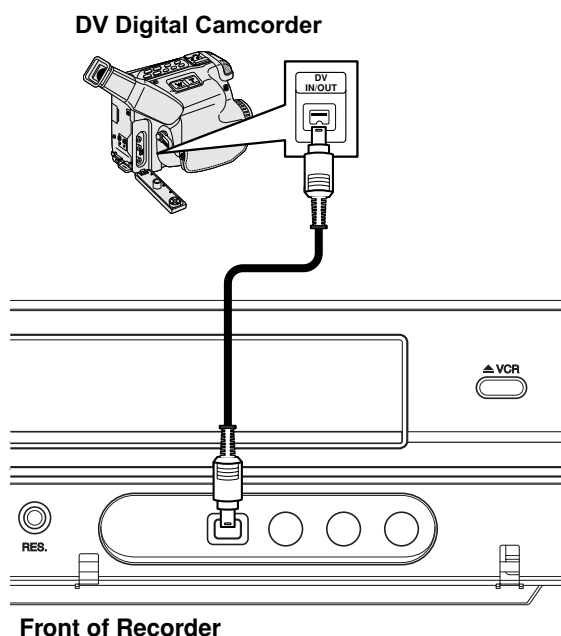

## Connecting the IR control cable

The Recorder sends commands to your connected Set-Top Box to change the channels through the IR control cable when AV1 timer recording starts.

1. Connect the plug of the IR control cable to the IR TRANSMITTER jack on the Recorder.
2. Find the Set-Top Box IR Sensor. Refer to "How to find the IR sensor on the Set-Top Box" on right.
3. On the IR control cable, attach the adhesive tape (included) to the flat surface just below of the IR Blaster on the IR control cable.
4. Place the IR Blaster in front of the IR sensor on your Set-Top Box approximately one inch away from the remote sensor.
- 5 After connecting, make the necessary setting (page 22).

### Notes:

- If your Set-Top Box does not have Audio/Video Out jacks, you cannot use the AV1 timer recording using this connection
- Important, for the Recorder to record programs received through the Set-Top Box, the Set-Top box must remain turned on at all times.
- If your Set-Top Box has IR and RF control together, set the control to IR on the Set-Top box to use this IR connection
- Do not connect an accessory other than the supplied IR control cable to the IR TRANSMITTER jack.
- Do not cover the transmitter.
- Not all Set-Top Box devices will work with this Recorder.
- Refer to the owner's manual of the connected Set-Top Box as well.

### Recommended Set-Top Box devices

- **Cable Box:** Motorola, Pioneer, Scientific Atlanta, Sony
- **Satellite Box:** DirecTV, Echostar, Dish NetWork, HTS, Hughes, JVC, Proscan, RCA, Sony
- **Digital Video Recorder:** Tivo, DirecTV, Dish NetWork, Scientific Atlanta, Motorola, Hughes, Humax, Philips, Sony

### Cable Box, Satellite Box, Digital Video Recorder or Other Set-Top Boxes

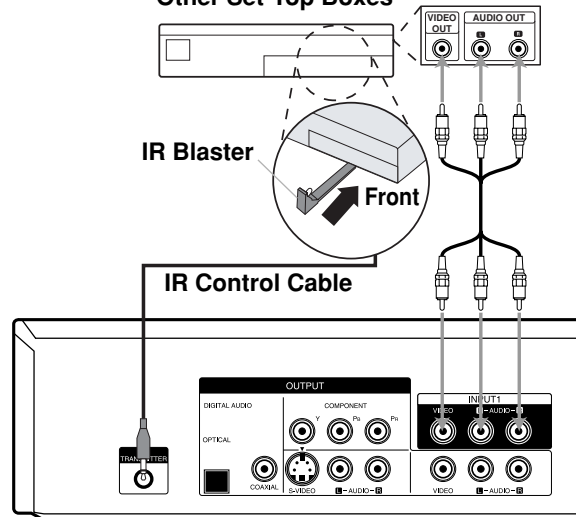

Rear of Recorder

### How to find the IR sensor on the Set-Top Box

1. Turn off the Set-Top Box.
2. Hold the Remote Control of the Set-Top Box so that it touches the front of the device.

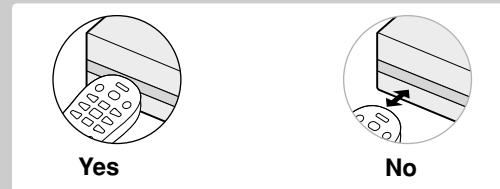

3. Slowly move the Remote Control across the front of the device while pressing POWER button On and Off. You must press and release the POWER button each time you move the Remote Control (holding down the button will not work).

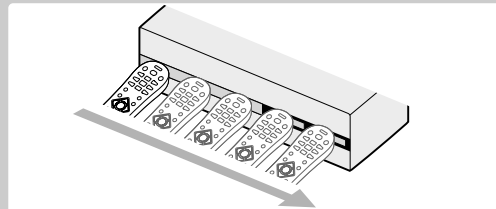

4. When the cable box turns on, you have found the sensor. Remember the location of the sensor.



## Initial Setup Wizard

After the POWER button is pressed for the first time to turn on the unit, the Initial Setup Wizard function sets the Language and Clock step-by-step until the setup is complete.

1. Use ▲ / ▼ to select a language for the Setup menu and information display then press ENTER.



2. Enter the necessary information for year, date and time.



◀ / ▶ (left/right): Moves the cursor to the previous or next column.

▲ / ▼ (up/down): Changes the setting at the current cursor position.

Press ENTER to confirm your setting.

3. Press ENTER to exit the menu.

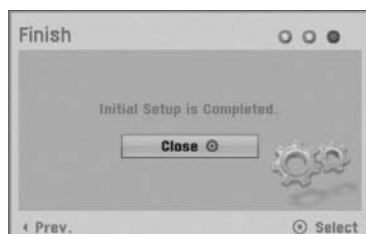

### Note:

You can reset the Initial Setup Wizard from the [Factory Set] in the setup menu.(see page 18).

## Using the Home Menu

From the Home Menu screen you can access all the Media for playback and recording of the recorder.

1. Press HOME and the Home menu appears.
2. Use ◀ / ▶ to select the desired main option.
3. Use ▲ / ▼ to select the desired Sub option then press ENTER to confirm your selection.



4. To exit the HOME menu, press HOME.

### Setup

- **Start:** Displays Setup menu.

### TV

- **Timer Record:** Displays [Timer Record List] menu. (See page 35)

### Movie

- **VCR:** Plays back Video tape.
- **DISC:**
  - Displays TITLE LIST menu for recordable disc (page 40)
  - Plays back DVD-Video disc (pages 27-29).

### Photo (See page 31-32)

- **DISC:** Displays [Photo List] menu for disc.

### Music (See page 30)

- **DISC:** Displays [Music List] menu for disc.

### Easy Menu

- **Dubbing:** Displays [Dubbing] menu.
- **Disc Manager:** Displays Disc Setup menu.
- **Rec. Mode:** Displays Record Mode setup menu.
- **DV Input:** Displays DV Input mode.

## Initial Settings

In this menu system, there are several ways to customize the settings provided. Most menus consist of three levels to set up the options, but some require greater depth for the variety of settings.

1. Press HOME and the Home menu appears.
2. Select [Setup] > [Start] and press ENTER.

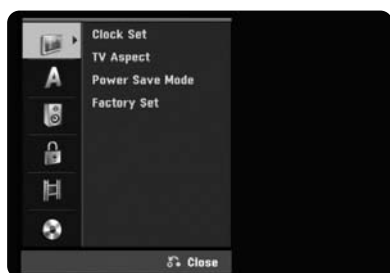

3. Use ▲ / ▼ to select the desired option.
4. While the desired item is selected, press ► to move to the second level.
5. Use ▲ / ▼ to select the second desired option.
6. Press ► to move to the third level.
7. Use ▲ / ▼ to select the desired setting then press ENTER to confirm your selection. Some items require additional steps.
8. Press RETURN (↵) or HOME to exit the Setup menu.

### Note:

Press ◀ to go back to the previous level.

## General Settings



### Clock Set

You can set the clock.

1. Select the [Clock Set] option then ►.
2. Enter the necessary information for year, date and time.
  - ◀ / ► (left/right): Moves the cursor to the previous or next column.
  - ▲ / ▼ (up/down): Changes the setting at the current cursor position.
3. Press ENTER to confirm your setting.

### TV Aspect

**[4:3 Letter Box]:** Select when a standard 4:3 TV is connected. Displays theatrical images with masking bars above and below the picture.

**[4:3 Pan Scan]:** Select when a standard 4:3 TV is connected. Displays pictures cropped to fill your TV screen. Both sides of the picture are cut off.

**[16:9 Wide]:** Select when a 16:9 wide TV is connected.

### Power Save Mode

Set Power Save Mode to [ON] to place your Recorder into an economic power save mode. Nothing is displayed in the display window when the unit is turned off.

### Factory Set

You can reset the Recorder to its original factory settings.

1. Select the [Factory Set] option.
2. Press ► to select [SET] then press ENTER.
3. Select [OK] and press ENTER.
4. Follow the Initial Setup Wizard on page 17.

## Language Settings



### Display Menu

Select a language for the Setup menu and information display.

### Disc Menu / Audio / Subtitle

**[Original]:** Refers to the original language in which the disc was recorded.

**[Others]:** To select another language, press number buttons then ENTER to enter the corresponding 4-digit number according to the language code list in the reference chapter (see page 49). If you enter the wrong language code, press CLEAR.

**[OFF]** (for Disc Subtitle): Turn off Subtitle.

## Audio Settings

Each DVD disc has a variety of audio output options. Set the Recorder's Audio Output according to the type of audio system you use.



### Dolby Digital / DTS / MPEG

**[Bitstream]:** Select [Bitstream] if you connect the DIGITAL AUDIO OUTPUT jack to an amplifier or other equipment with a Dolby Digital, DTS or MPEG decoder.

**[PCM]** (for Dolby Digital / MPEG): Select when connected to a two-channel digital stereo amplifier. DVDs encoded in Dolby Digital or MPEG will be automatically downmixed to two-channel PCM audio.

**[OFF]** (for DTS): If you select [OFF], the DTS signal is not output through the DIGITAL AUDIO OUTPUT jack.

### Sampling Freq. (Frequency)

If your receiver or amplifier is NOT capable of handling 96 kHz signals, select 48 kHz. When this choice is made, this unit automatically converts any 96 kHz signals to 48 kHz so your system can decode them.

If your receiver or amplifier is capable of handling 96 kHz signals, select 96 kHz. When this choice is made, this unit passes each type of signal through without any further processing.

Check the documentation for your amplifier to verify its capabilities.

### DRC (Dynamic Range Control)

With the DVD format, you can hear a program's soundtrack in the most accurate and realistic presentation possible, thanks to digital audio technology. However, you may wish to compress the dynamic range of the audio output (the difference between the loudest sounds and the quietest ones). This allows you to listen to a movie at a lower volume without losing clarity of sound. Set DRC to [ON] for this effect.

## Lock (Parental Control) Settings

### Rating

Blocks playback of rated DVDs based on their content. Not all discs are rated.

1. Select [Rating] option then press ►.

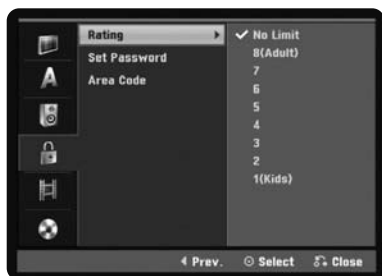

2. To access the Rating, Password and Area Code features, you must input the 4-digit security code you created.

If you have not yet entered a security code you are prompted to do so. Input a 4-digit code. Enter it again to verify. If you make a mistake press CLEAR.

3. Select a rating from 1 to 8 using the ▲ / ▼ buttons.

**[1]-[8]:** Rating one (1) has the most restrictions and rating eight (8) is the least restrictive.

**[No Limit]:** If you select [No Limit], parental control is not active and the disc plays in full.

4. Press ENTER to confirm your rating selection, then press HOME to exit the menu.
5. Press EJECT, OPEN/CLOSE (▲) to activate parental control.

#### **Note:**

If you set a rating for the recorder, all disc scenes with the same rating or lower are played. Higher rated scenes are not played unless an alternate scene is available on the disc. The alternative must have the same rating or a lower one. If no suitable alternative is found, playback stops. You must enter the 4-digit password or change the rating level in order to play the disc.

## Set Password

You can enter or change password.

1. Select [Set Password] option then press ►.
2. Follow step 2 as shown [Rating].

To change the password, press ENTER when the [Change] option is highlighted, then input old password. Input new password. Enter it again to verify.

To delete the password, select [Delete] option then press ENTER, then input old password. The password is deleted.
3. Press HOME to exit the menu.

### ***If you forget your password***

If you forget your password you can clear it using the following steps:

1. Press HOME and the Home menu appears.
2. Select [Setup] > [Start] and press ENTER.
3. Input the 6-digit number [210499]. The message appears, select [OK] then press ENTER. The security code is cleared.
4. Enter a new code as described above.

## Area Code

Enter the Area Code whose standards were used to rate the DVD video disc, based on the list in the reference chapter (see page 49).

1. Select [Area Code] option then press ►.
2. Follow step 2 as shown [Rating].
3. Select the first character using ▲ / ▼ buttons.
4. Shift the cursor using ► buttons and select the second character using ▲ / ▼ buttons.
5. Press ENTER to confirm your area code selection, then press HOME to exit the menu.

## Recording Settings



### Disc Record Mode

You can set the picture quality for recording; XP (High Quality), SP (Standard Quality), LP (Low Quality), EP (Extend Quality), MLP (Maximum Long Play).

1. Select the [Disc Record Mode] option then press ►.
2. Use ▲ / ▼ to select a desired Disc Record Mode (XP, SP, LP, EP or MLP).
3. Press ENTER to confirm your selection, then press HOME to exit the menu.

### VCR Record Mode

You can set the picture quality for VCR recording; SP (Standard Play), SLP (Super Long Play).

### DV Record Audio

You need to set this if you have a camcorder using 32kHz/12-bit sound connected to the front panel DV IN jack. Some digital camcorders have two stereo tracks for audio. One is recorded at the time of shooting; the other is for overdubbing after shooting. On the Audio 1 setting, the sound that was recorded while shooting is used. On the Audio 2 setting, the overdubbed sound is used.

### Auto Chapter

During recording, chapter markers are added automatically at fixed intervals. You can set this interval to 5 minutes or 10 minutes. To turn off automatic chapter marking, select [None].

#### **Note:**

If [Disc Record Mode] option is set to [MLP], the [5 Min] option is not selectable.

## Set-Top Box Control

Select [ON] when you connect a Set-Top Box (Cable Box, Satellite Box, Digital Video Recorder, etc) with IR control cable. If not, select [OFF].

## Set-Top Box Edit

This setting is available only if the [Set-Top Box Control] option is set to [ON]. If you connect the Recorder to the Set-Top Box as described in page 16 so the Recorder can change the channels on the connected Set-Top Box when timer recording of AV1 input starts.

1. Select [Set-Top Box Edit] on the setup menu then press **▶**. The [Edit] icon is highlighted.
2. Press ENTER while the [Edit] icon is highlighted. [Set-Top Box Control] menu shows the current settings.

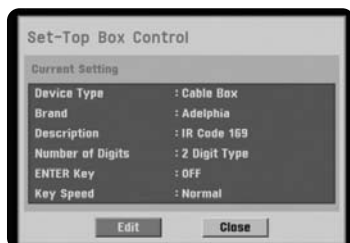

3. If you want to edit the settings, use **◀ / ▶** to select [Edit] icon then press ENTER. The [Set-Top Box Edit] menu appears.



4. Use **▲ / ▼** to select a main option then press ENTER.
  - [Device Type] Selects the device type.
  - [Brand] Selects the brand of the Set-Top Box.
  - [Number of Digits] Selects the number of digits of the Set-Top Box's channel.
  - [Enter Key] If your device needs ENTER key to change channels, select [ON]. If not, select [OFF].
  - [Key Speed] Select a Key Speed that the recorder sends commands to the connected Set-Top Box.
5. Use **▲ / ▼** to select a sub option then press ENTER.
6. Use **▲ / ▼** to select [Test] option then press ENTER to verify the connections/settings between the Set-Top Box and the Recorder. The recorder is tuned to AV1 automatically. See right for details.

## Test Procedure



- 1) Check the IR control cable connection then press ENTER. (Refer to page 16.)



- 2) Turn on the Set-Top Box then press ENTER.



- 3) Use **◀ / ▶** a Remote Control Code of the device then press ENTER.

The list of codes displayed onscreen are based on the device type and brand you selected. Each brand of the device can have multiple sets of codes. One code will be tested at a time; if the code does not work, select another code to test.



- 4) Use **▲ / ▼ / ◀ / ▶** and ENTER to select a channel.

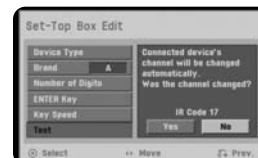

- 5) Confirm that your Set-Top Box's channel is changed to the selected channel in step 4.

If changed, select [Yes] then press ENTER.

If not changed, select [No] then press ENTER and repeat from step 3.

- Some Set-Top boxes may not be controlled if the device needs sub channel input - the same as 19-1.

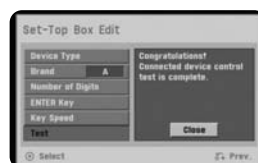

- 6) The Test procedure is complete, press ENTER to exit the menu.

### If you fail to test

- Make sure IR Control Cable connection. (page 16)
- Set the [Set-Top Box Edit] options again then proceed to the [Test] option.
- If IR control is not activated even though you set again, the Recorder may not control your Set-Top Box according to the device's maker or status. Confirm recommended Set-Top Box on page 16 or contact your Set-Top Box provider.

## Disc Settings

### Initialize

If you load a completely blank disc, the recorder will initialize the disc.

- DVD-R: The recorder initialize the disc to Video mode. The recording mode will always be Video mode.
- DVD-RW/ DVD+RW/DVD+R(DL)/DVD-RAM: The Initialize menu will appear. Select [OK] then press ENTER. DVD-RW disc is initialized to Video mode.

Also, you can reformat the DVD-RW/DVD+RW/ DVD-RAM from the Setup menu as below.



1. Select the [Initialize] option then press ►. [Start] icon is highlighted.
2. Press ENTER.
  - In case of DVD-RW, use ◀ / ▶ to select a desired Disc Initialize Mode (VR Mode or Video Mode) then press ENTER.
  - In case of DVD+RW/DVD-RAM, use ◀ / ▶ to select [OK], and press ENTER. It takes a few moments to format the disc.

#### Caution:

If you want to change the disc format, everything recorded on the disc will be erased.

### Finalize

Finalizing 'fixes' the recordings in place so that the disc can be played on a regular DVD player or computer equipped with a suitable DVD-ROM drive. Finalizing a Video mode disc creates a menu screen for navigating the disc. This is accessed by pressing DISC MENU/LIST or TITLE.

#### Caution:

Once you have finalized a DVD-R and DVD+R (DL) disc, you cannot edit or record anything else on that disc except DVD+RW. However, you can record and edit a DVD-RW disc by choosing [Unfinalize] option.

1. Select the [Finalize] option then press ►.
2. Press ENTER while [Finalize] is selected. Finalize menu appears.

3. Select [OK] then press ENTER. The Recorder starts finalizing the disc.

#### Notes:

- Finalization can take up to 3-4 minutes or more depending on the type of disc, how much is recorded on the disc, and the number of titles on the disc.
- DVD+R DL disc can take up to 30 minutes to finalize.

#### Tips:

- If you load a DVD-RW that has already been finalized, you can 'Unfinalize' it by choosing [Unfinalize] from the Finalize menu. After doing this, you can edit and re-record onto the disc.
- You cannot unfinalize a DVD-R and DVD+R (DL) disc.
- If [Disc Protect] option is set to [ON], the finalize is not available. To finalize, set [Disc Protect] option to [OFF].

### Disc Label

Use the Disc Label feature to enter a name for the disc. This name appears when you load the disc and when you display disc information on-screen.

- The Disc label can be up to 32 characters long.
- For discs formatted on a different Recorder, you will see only a limited character set.

1. Select the [Disc Label] option then press ►. [Edit] icon is highlighted.
2. Press ENTER. Keyboard menu appears. To enter characters, see page 44.

### Disc Protect

Depending on the type of disc you are using, Disc Protect allows you to preserve your recordings in a variety of ways:

- DVD+RW: Prevents editing, erasing, or overwriting of existing recordings. Allows regular recording.
- DVD+R: Prevents editing or erasing of existing recordings. Allows regular recording.
- DVD-RW (VR mode)/DVD-RAM: Prevents editing, erasing, and regular recording.

#### Notes:

- Disc Protect is not compatible with DVD-RW discs in Video mode or DVD-R discs.
- If you need to unlock a disc to make edits, select [OFF].

### AutoPlay

When you load a DVD with AutoPlay turned on, the Recorder will bypass the Disc menu and trailers and start playing the movie automatically.

Set [AutoPlay] to [ON] or [OFF].

## General Explanation of On-Screen Display

Some DVDs require specific operation or allow only limited operation during playback. When this occurs,

⊘ is displayed, action prohibited or not available.

## Displaying Information While Watching AV input source

While watching TV, press DISPLAY to display/remove the information displayed on-screen.

e.g., when DVD-RW in VR mode is inserted.

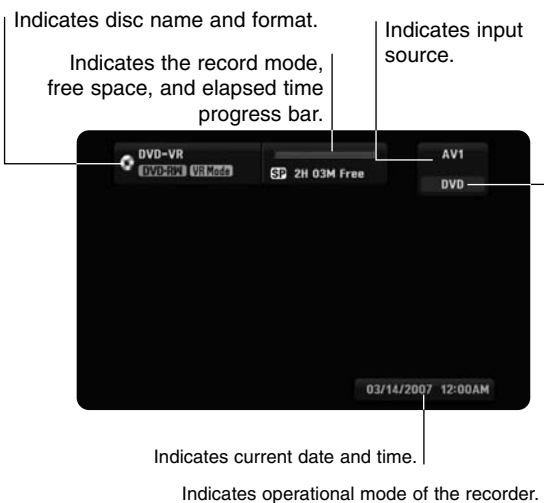

## Displaying Disc Information on-screen

You can display various information about the disc or tape loaded on-screen. Some items can be changed using the menu.

1. Press DISPLAY once to show current status.

Example: DVD-RW in VR mode

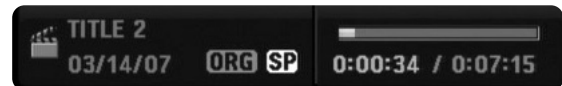

2. Press DISPLAY once again to show various playback information. The items displayed differ depending on the disc type or playing status.

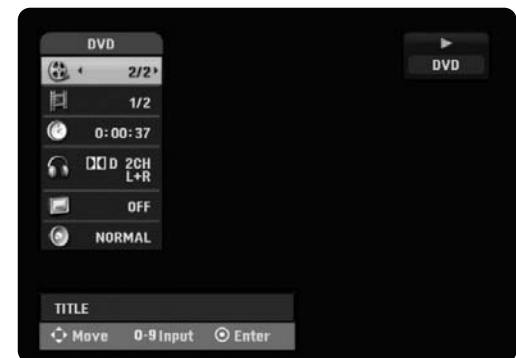

3. You can select an item by pressing ▲ / ▼ and change or select the setting by pressing ◀ / ▶. For details about each item, see the pages in parenthesis.
  - [Title]: Current title number/total number of titles (page 29)
  - [Chapter]: Current chapter number/total number of chapters (page 27)
  - [Time]: Elapsed playing time (page 29)
  - [Audio]: Selected audio language (DVD VIDEO only) or audio channel (page 28)
  - [Subtitle]: Selected subtitle (page 27)
  - [Angle]: Selected angle/total number of angles (page 29)
  - [Sound]: Selected sound mode (page 29)

### Note:

If no button is pressed for 10 seconds, the on-screen display disappears.



# Playback

## Playing a Tape

1. Press VCR to control the VCR deck.
2. Insert a pre-recorded video cassette.
  - If the unit is powered off, it will power on automatically when the tape is loaded.
  - If the Timer indicator lights on the front panel display window, press POWER once.
3. Press PLAY (▶) to start playback.
  - If a tape without a safety tab is inserted the unit starts playback automatically.
4. Press STOP (■) to stop playback.
  - If the tape reaches the end before you press STOP (■) the Recorder automatically stops, rewinds and ejects the tape.

### **Note:**

#### S-VHS Quasi Playback (SQPB)

- This Recorder can play back S-VHS recorded tapes, however, it cannot make recordings using S-VHS format tapes.
- SQPB is an abbreviation for S-VHS Quasi Playback.

## Playing a DVD

1. Press DVD to control the DVD deck.
2. Press EJECT, OPEN/CLOSE (▲) to open the disc tray. Load your chosen disc in the tray, with the playback side down.
3. Press EJECT, OPEN/CLOSE (▲) to close the tray. Playback starts automatically. If playback does not start, press PLAY (▶) or Starts playback using HOME menu.
4. To stop the playback, press STOP (■). The unit records the stopped point, depending on the disc. "||■" appears on the screen briefly. Press PLAY (▶) to resume playback (from the scene point). If you press STOP (■) again or unload the disc ("■" appears on the screen.), the unit will clear the stopped point.
5. Press EJECT, OPEN/CLOSE (▲) to remove the disc. Press EJECT, OPEN/CLOSE (▲) to close disc tray or press POWER (⏻), the disc tray closes automatically and unit turns off.

### **Note:**

If parental control is set and the disc is not within the rating settings you must input the password. (See [Rating] on page 20).

## VCR Playback Options

| Buttons       | Operations  |
|---------------|---|
| EJECT (▲)     | Ejects the tape in the VCR deck.  |
| PAUSE (  )    | Pause playback.<br><br>Press repeatedly to step forward one frame at a time. <ul style="list-style-type: none"><li>• After 5 minutes in STILL mode the Recorder stops to protect the tape and video heads.</li></ul>  |
| FORWARD (▶▶)  | Scan forward. In Stop mode, fast forwards the tape. In Pause mode, starts slow motion playback. <ul style="list-style-type: none"><li>• After 3 minutes in SEARCH mode the Recorder returns to PLAY mode to protect the tape and video heads</li><li>• After 3 minutes in SLOW MOTION mode the Recorder goes back to PLAY mode to protect the tape and video heads.</li></ul> |
| BACKWARD (◀◀) | Scan backward. In Stop mode, rewinds the tape. <ul style="list-style-type: none"><li>• After 3 minutes in SEARCH mode the Recorder returns to PLAY mode to protect the tape and video heads.</li></ul>  |
| CLEAR         | Resets the current tape counter position to 0:00:00. To automatically goto tape counter position 0:00:00, press RETURN while the tape is in Stop mode or in Play mode.  |
| TRK (+/-)     | Manually reduces noise on the screen during tape playback. Tracking is set automatically when a tape is inserted.   |
| AUDIO         | Sets tape audio to HIFI, LEFT, RIGHT or NORMAL. Use ◀/▶ buttons to select tape audio you want.  |
| I.SKIP        | Press repeatedly during playback to skip forward 30 seconds (maximum 180 seconds).  |

## DVD Playback Features

| Buttons                      | Operations   | Discs  |
|------------------------------|--|--|
| OPEN / CLOSE (▲)             | Opens or closes the disc tray.   | All Discs  |
| PAUSE (⏸)                    | Pause playback.<br><br>Press repeatedly to play Frame-by-Frame.<br>You can also use ◀ / ▶ to step backward and forward while in Pause mode.  | All Discs<br><br><b>DVD ALL</b>                    |
| BACKWARD (◀◀) / FORWARD (▶▶) | <br>During playback, press repeatedly to select the required scan speed.<br>- DVD; 5 steps,<br>- Audio CD; 3 steps<br><br>In Pause mode, press BACKWARD (◀◀) / FORWARD (▶▶) for slow motion playback (4 steps).  | <b>DVD ALL</b> <b>ACD</b><br><br><b>DVD ALL</b>    |
| SKIP (◀◀◀ / ▶▶▶)             | During playback, press SKIP (▶▶▶ or ◀◀◀) to go to the next chapter/track or to return to the beginning of the current chapter/track.<br>Press SKIP ◀◀◀ twice briefly to step back to the previous chapter/track.<br><br><ul style="list-style-type: none"> <li>To go directly to any chapter during DVD playback, press DISPLAY twice and press ▲ / ▼ to select the chapter icon. Then, input the chapter number or use ◀ / ▶.</li> <li>On an Audio CD, to go directly to any track, enter the track number using the numbered buttons (0-9) during playback.</li> </ul> | <b>DVD ALL</b> <b>ACD</b> <b>MP3</b><br><b>WMA</b> |
| ZOOM                         | Enlarge the video image.<br>(x1 size → x2 size → x4 size → x1 size (normal size))<br>You can move through the zoomed picture using ◀ ▶ ▲ ▼ buttons.  | <b>DVD ALL</b>                                     |
| TITLE                        | If the current DVD title has a menu, the title menu appears on the screen. Otherwise, the disc menu may appear.  | <b>DVD</b> <b>+RW</b> <b>+R</b>                    |
| DISC MENU/LIST               | The disc menu appears on the screen.   | <b>DVD</b>   |
| SUBTITLE (🗨)                 | During playback, press SUBTITLE then press ◀ / ▶ repeatedly to select a desired subtitle language.   | <b>DVD</b>   |
| I.SKIP                       | Press repeatedly during playback to skip forward 30 seconds.   | <b>DVD ALL</b>                                     |

## DVD Playback Features (Continued)

| Buttons     | Operations  | Discs   |
|-------------|---|---|
| PLAY MODE   | Select a desired play mode while playback.  |   |
|             | [A-]: Repeats a sequence between A (Start point) and B (End point) during playback. Press ENTER at your chosen end point then the repeat sequence begins.   | <b>DVD ALL</b> <b>ACD</b><br><b>Karaoke DVD</b> |
|             | [CHAPTER]: Repeats the current chapter.   | <b>DVD ALL</b>                                  |
|             | [TITLE]: Repeats the current title.   | <b>DVD ALL</b> <b>Karaoke DVD</b>               |
|             | [ALL]: Repeats the all titles/tracks.   | <b>ACD</b> <b>-RW<sub>VR</sub></b> <b>RAM</b>   |
|             | [Track]: Repeats the current track.   | <b>ACD</b> <b>MP3</b> <b>WMA</b>                |
|             | [RANDOM]: Random playback   | <b>Karaoke DVD</b>                              |
|             | [Folder]: Repeats all the tracks on a folder of a disc.   | <b>MP3</b> <b>WMA</b>                           |
|             | [OFF]: Does not play repeatedly.  | <b>DVD ALL</b>                                  |
|             | <ul style="list-style-type: none"> <li>• If you press SKIP (▶▶ ) once during Repeat Chapter (Track) playback, the repeat playback cancels.</li> <li>• By pressing SKIP (▶▶ ) during Random playback, the Recorder selects another title (track) and resumes Random playback.</li> </ul> |   |
| AUDIO ( ⌂ ) | Press AUDIO then press ◀ / ▶ repeatedly to hear a different audio language, audio track or encoding method.   | <b>DVD</b>                                      |
|             | <p><b>Note:</b><br/>Some discs feature both Dolby Digital and DTS soundtracks. There is no analog audio output when DTS is selected. To listen to the DTS soundtrack, connect this recorder to a DTS decoder via one of the digital outputs. See page 14 for connection details.</p>    |   |
|             | Press AUDIO then press ◀ / ▶ repeatedly during playback to hear a different audio channel.  | <b>DVD ALL</b>                                  |

## Special Playback Options

### If a menu screen is displayed **DVD**

In some cases, the disc menu might appear instead.

#### **DVD**

Use the ◀▶▲▼ buttons to select the title/chapter you want to view, then press ENTER to start. Press TITLE or DISC MENU/LIST to return to the menu screen.

### Moving to another TITLE **DVD ALL**

When a disc has more than one title, you can move to another title as follows:

- Press DISPLAY twice during playback or in stop mode then use ▲ / ▼ to select the title icon. Then, press the appropriate numbered button (0-9) or ◀ / ▶ to select a title number then press ENTER.

### Time Search **DVD ALL**

To start playing at any chosen time on the disc:

1. Press DISPLAY twice during playback. The time search box shows the elapsed playing time.
2. Press ▲ / ▼ to select the time clock icon and [-:--:-] appears.
3. Input the required start time in hours, minutes, and seconds from left to right. If you enter the wrong numbers, press ◀ / ▶ to move the under bar ( ) to the wrong number. Then enter the correct numbers.
4. Press ENTER to confirm. Playback starts from the selected time.

### Marker Search **DVD ALL**

#### To enter a Marker

You can start playback from up to six memorized points. To enter a marker, press MARKER at the desired point on the disc. The Marker icon appears on the TV screen briefly. Repeat to enter up to six markers.

#### To Recall or Clear a Marked Scene

1. During disc playback, press SEARCH. The marker search menu appears on the screen.
2. Use ◀▶/▲/▼ to select a marker scene that you want to recall or clear.
3. Press ENTER and playback starts from the marked scene, or Press CLEAR and use ◀ / ▶ to select [OK] then press ENTER to delete marked scene from the list.
4. To remove the Marker Search menu, press RETURN (↵).

### Camera Angle **DVD**

If the disc contains scenes recorded at different camera angles, you can change to a different camera angle during playback. Press DISPLAY twice then select the Angle icon during playback. Use ◀ / ▶ to select a desired angle. Note that the number of the current angle appears on the display.

#### **Tip:**

The Camera Angle icon is displayed on the TV screen when alternate angles are available.

### 3D Surround **DVD ALL**

This unit can produce a 3D Surround effect, which simulates multi-channel audio playback from two conventional stereo speakers, instead of the five or more speakers normally required to listen to multi-channel audio from a home theater system.

1. Press DISPLAY twice then use ▲ / ▼ to select the sound icon. Then, use ◀ / ▶ to select [3D SUR.].
2. To turn off the 3D Surround effect, select [NORMAL].

### Last Scene Memory **DVD**

This Recorder memorizes last scene from the last disc that is viewed. The last scene remains in memory even if you remove the disc from the Recorder or switch off the Recorder. If you load a disc that has the scene memorized, the scene is automatically recalled.

#### **Notes:**

- Settings are stored in memory for use any time.
- This Recorder does not memorize settings of a disc if you switch off the Recorder before commencing to play it.
- Last Scene Memory function for a previous DVD title is erased once a different DVD title is played.

## Playing an Audio CD or MP3/WMA files

The Recorder can play Audio CDs and MP3/WMA files. Before playing MP3/WMA files, read [MP3/WMA audio file requirement] on right.

1. Press HOME and the Home menu appears.
2. Select [Music] > [DISC] and press ENTER. The [Music List] menu appears on the TV screen.



Example) Audio CD

3. Use ▲/▼ to select a track or file then press PLAY (▶). Playback starts. You can use variable playback functions. Refer to pages 27-28.
4. To stop playback at any time, press STOP (■).

### Tips:

- You can view video input source by pressing RETURN (↵). If you want to return to the [Music List] menu, press DISC MENU/LIST.
- Press DISPLAY to view ID3-Tag information for the MP3 file. If ID3-Tag information is not present, [ID3-Tag: None] will appear. If you select a folder, the number of subfolders and number of MP3/WMA files in the folder are displayed. Press DISPLAY again to remove the information screen.
- On CDs or DVDs with mixed content (Audio tracks, MP3/WMA files or JPEG files), you can select between the [Music List] menu and [Photo List] menu by pressing TITLE repeatedly.
- If you are in a file list and want to return to the Folder list, use the ▲/▼ to highlight [ ] and press ENTER to return to the previous menu screen.

## Music List menu options

1. Press ▲ / ▼ to select a track/file or folder on the [Music List] menu then press ENTER.



2. Use ▲ / ▼ to select an option, then press ENTER.
  - **[Play]** Start playback the selected track or file.
  - **[Open]** Opens the folder and a list of files in the folder appears.
  - **[Random]** Start or stop random playback.

### Random

1. Press ▲ / ▼ to select a file then press ENTER. The menu options appear.
2. Press ▲ / ▼ to select [Random] option then press ENTER. The unit automatically begins random playback and "RANDOM" appears on the menu screen.
3. To return to normal playback, select [Random] option again then press ENTER.

### Tip:

By pressing SKIP (◀◀/▶▶) during Random playback, the unit selects another track and resumes Random playback.

## MP3/WMA audio file requirement

### File extensions

".mp3", ".wma".

### Sampling frequency:

within 8 - 48 kHz (MP3), within 32 - 48kHz (WMA)

### Bit rate: within:

8 - 320kbps (MP3), 32 - 192kbps (WMA)

### CD-R Format:

ISO 9660 and JOLIET.

### DVD±R/RW Format:

ISO 9660 (UDF Bridge format)

### Maximum Files/Disc:

Less than 1999 (total number of files and folders)

## Viewing a JPEG files

This unit can play JPEG files. Before playing JPEG recordings, read "Photo file requirement" on page 32.

1. Press HOME and the Home menu appears.
2. Select [Photo] > [DISC] and press ENTER.
3. Use ▲▼◀▶ to select a file or folder and press ENTER.



2. Use ▲ / ▼ to select option and press ENTER.

*Example: When you select a file.*



3. Use ▲ / ▼ to select [Full Screen] then press ENTER.  
The selected image is displayed in full screen.



Press ENTER to make this menu appear or disappear.

4. To stop viewing at any time, press STOP (■).

### Notes:

- If the  icon displays in the [Photo List] menu, it means you cannot see those JPEG files.
- You can view video input source by pressing RETURN (↵). If you want to return to the [Photo List] menu, press DISC MENU/LIST.
- If you are in a file list and want to return to the Folder list, use the ▲/▼ to highlight  and press ENTER to return to the previous menu screen.
- On CDs or DVDs with mixed content (Audio tracks, MP3/WMA files or JPEG files), you can select between the [Music List] menu and [Photo List] menu by pressing TITLE repeatedly.

## Photo List menu options

1. Use ▲▼◀▶ to select a file then press ENTER.  
The menu options appear.



2. Use ▲ / ▼ to select an option then press ENTER to confirm your selection.
  - **[Open]** Opens the folder and a list of files in the folder appears.
  - **[Full Screen]** Shows the selected file as full screen.
  - **[Slide Show]** Displays Slide Show menu.

### Still picture

Use PAUSE/STEP (⏸) while viewing slide show to pause mode.

### Skip Images

While viewing a picture, press SKIP (▶▶ or ◀◀) once to advance to the next file or return to the previous file.

### Rotate Images

Use ▲ / ▼ while viewing a picture to flip the picture clockwise or counterclockwise.

## View Slide Shows

1. Select [Slide Show] option on the [Photo List] menu.
2. Press ENTER.

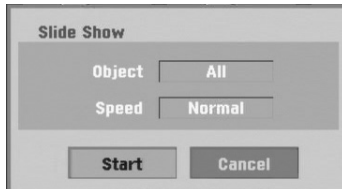

3. Use ◀ / ▶ / ▲ / ▼ to set the options.  
**[Object]** option:
  - [Selected] Views slide show only selected files.
  - [All] Views slide show all files.**[Speed]** option:  
Sets the Slide Show speed to [Normal], [Slow], or [Fast].
4. Select the [Start] option then press ENTER to start the Slide Show.
5. Press STOP (■) to stop the Slide Show and returns to the [Photo List] menu.

### Tips:

- Selecting multiple files
  1. Press **MARKER**.  
*A check mark appears on the file. Press **MARKER** again to cancel the marked file.*
  2. Repeat step 1 to mark additional file.
- Use the **CLEAR** button to select all files, or cancel all marked files.

## Photo file requirement

### File extensions

“.jpg”

### Photo size:

Less than 4MB recommended

### CD-R Format:

ISO 9660 and JOLIET.

### DVD±R/RW Format:

ISO 9660 (UDF Bridge format)

### Maximum Files/Disc:

Less than 1999 (total number of files and folders)

### Notes on JPEG file

- Progressive and lossless compression JPEG image files are not supported.
- Depending on the size and number of the JPEG files, it may take several minutes to read the contents of the media.



# Recording

## About DVD recording

### Notes:

- This Recorder cannot record CD-R or CD-RW discs.
- Fingerprints and small scratches on a disc can affect playback and/or recording performance. Please take proper care of your discs.
- The company does not hold any responsibility to compensate the contents which should have been recorded, and any losses or damages (e.g. losses of business profit, or business intermission) that may arise from malfunction of this recorder (not recording/editing as intended).

### Disc types and recording formats, modes, and settings

This recorder can play many different kinds of DVD discs: pre-recorded DVD-Video discs, DVD-RW, DVD-R, DVD+RW, DVD+R(DL) and DVD-RAM discs. The disc format for DVD-R, DVD+R(DL), DVD+RW discs is always "Video format"—the same as pre-recorded DVD-Video discs. This means that once finalized, you can play a DVD-R, DVD+R (DL), or DVD+RW in a regular DVD player. The DVD-RAM disc format is Video Recording (VR) format. The DVD-RW disc format is Video Recording (VR) format or Video format. You can change Recording format, if required. (Reinitializing the disc will erase the contents of the disc.)

The recording mode is closely related to the disc format. If the disc format is Video Recording format, then the recording mode is VR mode; if the disc format is Video format, then the recording mode is Video mode (except for DVD-Video, which is not recordable, and so does not have a recording mode). These can be changed as required for each recording and determine the picture quality and how much space the recording will take up on the disc.

### Notes for recording

- The recording times shown are not exact because the recorder uses variable bit-rate video compression. This means that the exact recording time will depend on the material being recorded.
- When recording, if the reception is poor or the picture contains interference, the recording times may be shorter.
- If you record still pictures or audio only, the recording time may be longer.

- The displayed times for recording and time remaining may not always add up to exactly the length of the disc.
- The recording time available may decrease if you heavily edit a disc.
- If using a DVD-RW disc, make sure you change the recording format (Video mode or VR mode) before you record anything on the disc. See page 23 (Initialize) for how to do this.
- When using a DVD-R or DVD+R disc, you can keep recording until the disc is full, or until you finalize the disc. Before you start a recording session, check the amount of recording time left on the disc.
- When using a DVD-RW disc in Video mode, recording time available will only increase if you erase the last title recorded on the disc.
- The Delete Title option in the Title List (Original) menu only hides the title, it does not actually erase the title from the disc and increase the recording time available (except for the last recorded title on a DVD-RW disc in Video mode).
- Overwrite recording is available using DVD+RW discs.
- When using a DVD+R/RW, the recorder will execute the Menu-making operation to update the new title and editing when removing the disc from the recorder.
- The recordable time of MLP mode with DVD+R DL discs is about 11 hours which is similar to single layer discs, because the resolution of DVD+R DL disc is higher than that of single layer disc.

## Recording time and picture quality

There are five preset recording quality modes:

- **XP** – Highest quality setting, gives about 1 hour of recording time on a DVD (4.7GB).
- **SP** – Default quality, sufficient for most applications, gives about 2 hours of recording time on a DVD (4.7GB).
- **LP** – Slightly lower video quality, gives about 4 hours of recording time on a DVD disc (4.7GB).
- **EP** – Low video quality, gives about 6 hours of recording time on a DVD (4.7GB).
- **MLP** – The longest recording time with the lowest video quality, gives you about 11 hours of recording time on a DVD (4.7GB).

### Note:

You may see a fragmented picture during playing back the contents recorded in EP or MLP mode.

## Recording from External Components

You can record from an external component, such as a camcorder or VCR, connected to any of the Recorder's external inputs.

1. Make sure that the component you want to record from is connected properly to the Recorder. See page 15.
2. Press AV/INPUT repeatedly to select the external input to record from.
  - AV1: Audio/Video Input mounted on back panel.
  - AV2: Audio/Video Input mounted on front panel.
  - DV: DV Input mounted on front panel.
3. Load a recordable disc or tape.
4. Set a recording mode as necessary by pressing REC MODE repeatedly.  
DVD: XP, SP, LP, EP or MLP.  
VCR: SP or SLP
5. Press ● REC once to start recording. The REC indicator lights in the display window.
6. Press STOP (■) to stop recording.

### Notes:

- Check that the Audio In settings DV Record Audio are as you want them. See page 21.
- If your source is copy-protected using CopyGuard, you will not be able to record it using this recorder. See Copyright on page 8 for more details.
- Recording continues until you press STOP (■) or the disc is full.
- To record for a fixed length of time, see [Instant Timer Recording] on this page.

## Instant Timer Recording

Instant Timer Recording allows you to make a recording easily of a preset length without using the program timer.

1. Follow steps 1-4 as shown left (Basic Recording from a TV).
2. Press ● REC repeatedly to select the recording time length. Recording starts after the first press.  
DVD: Each subsequent press increases the recording time by 10 minutes.

VCR: Each subsequent press increases the recording time by 30 minutes (maximum 540 minutes). Please confirm the VHS tape has enough remaining time to be recorded before recording.

## Checking the Recording Time

Press ● REC or DISPLAY once to check the recording time. The recalled setting will automatically return to the TV screen for a moment.

Also, remaining time of recording is shown in the display window.

## To Extend the Recording Time

The recording time can be extended anytime by pressing ● REC.

Each subsequent press increases the recording time by 10 minutes (DVD) or 30 minutes (VCR).

## To Pause the Recording

1. Press PAUSE/STEP (||) to pause the recording.
2. When you want to continue recording, press PAUSE/STEP (||) or ● REC.

### Notes:

- If you press PAUSE/STEP (||) during the Instant Timer Recording, it will be canceled.
- The Recorder will automatically power off when the Instant Timer Recording ends.
- If the unit is DVD mode when the VCR Instant timer recording ends, the unit will not automatically power off.

## Simultaneous Play and Record

You can play a DVD during the VCR recording, press DVD to change DVD mode and perform the DVD playback.

### Notes:

- You cannot play or record both DVD and VCR at the same time.
- You cannot change VCR mode during the DVD recording mode.
- If you wish VCR playback or record during the DVD playback, press VCR to change VCR mode and perform the VCR playback or recording.

## Timer Recording

The Timer Recording function allows you to record up to 16 programs within a period of one month.

1. Press HOME and the Home menu appears.
2. Select [TV] > [Timer Record] and press ENTER.

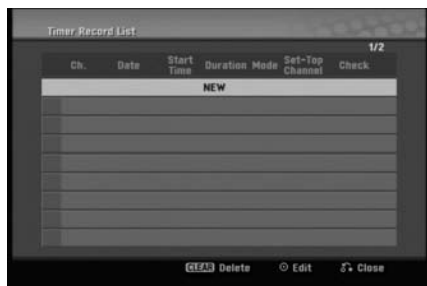

3. Select [NEW] and press ENTER. The Timer Record menu will appear.

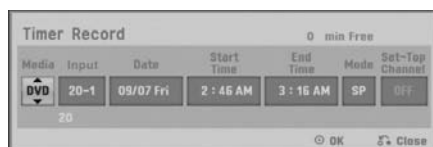

- [Media] – Choose a media (DVD or VCR).
- [Input] – Choose one of the external inputs from which to record (AV1 or AV2).
- [Date] – Choose a date up to 1 month in advance, or select a daily or weekly program.
- [Start Time] – Set the recording start time.
- [End Time] – Set the recording end time.
- [Mode] – Choose a record mode.  
DVD: XP, SP, LP, EP, MLP or AT (Auto)  
VCR: SP, SLP or AT (Auto)  
AT(Auto) mode determines how much time is available on the disc or tape and switches record mode, if necessary, to complete recording the program.
- [Set-Top Channel] – Choose a channel or [OFF] for AV1 input timer recording. For AV1 input timer recording using [Set-Top Channel] option, refer to page 36.

4. Enter the necessary information for your timer recording(s).
  - ◀ / ▶ (left/right) – Move the cursor left/right
  - ▲ / ▼ (up/down) – Change the setting at the current cursor position.
  - Press RETURN (↵) to return to the [Timer Record List] menu.
5. Press ENTER to save the program.
6. Press RETURN (↵) to exit the [Timer Record List] menu.

### Notes:

- You must insert a recordable disc or tape.
- The Timer indicator lights on the front panel display.
- The Recorder will automatically power off when the Timer Recording ends.
- If the unit is DVD mode when the VCR timer recording ends, the unit will not automatically power off.
- There is a short delay when a timer recording finishes to confirm the recorded program. If two timer recordings are set to record sequentially (one right after the other), the very beginning of the later program may not be recorded.
- You must press STOP (■) to stop the Timer Recording.

## Checking Timer Recording Details

Programming can be checked whenever the Recorder is turned on.

1. Press HOME and the Home menu appears.
2. Select [TV] > [Timer Record] and press ENTER.
3. Use ▲ / ▼ to select a program.
4. Press ENTER to edit the selected program. Timer Record menu appears.

## Canceling a Timer Recording

You can clear a timer setting anytime before the recording actually starts.

- Use ▲ / ▼ to select a program you want to erase on the [Timer Recorder List] menu, then press CLEAR and select [OK] then press ENTER.

## AV1 Timer Recording using Set-Top Channel option

1. Connect a Set-Top Box as shown on page 16.
2. Make the necessary settings for the connection as shown on page 22.
3. Important, for the Recorder to record programs received through the Set-Top Box, the Set-Top box must remain turned on at all times.
4. Select [TV] > [Timer Record] and press ENTER.

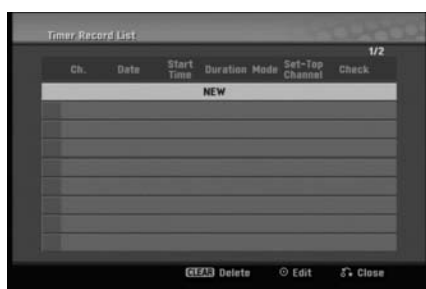

5. Select [NEW] and press ENTER. The Timer Record menu will appear.
6. Enter the necessary information for your timer recording(s).
  - ◀ / ▶ (left/right) – Move the cursor left/right
  - ▲ / ▼ (up/down) – Change the setting at the current cursor position.
  - Press RETURN (↵) to exit the Timer Record menu.
7. Set the [Input] option to [AV1].

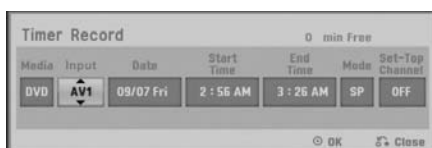

8. Set the [Media], [Date], [Start Time], [End Time], and [Mode] options according to previous page.
9. Set the [Set-Top Channel] option.
  - Select a channel using number or ▲ / ▼ buttons, the Recorder sends commands to change the channel of the connected Set-Top Box through the IR control cable.
  - Select [OFF] using CLEAR button, if you do not need the changing the channel of the Set-Top Box.



10. Press ENTER to save the program.
11. Press RETURN (↵) to exit the [Timer Record List] menu.

### Notes:

- You must insert a recordable disc or tape.
- The Timer indicator lights on the front panel display.
- The Recorder will automatically power off when the Timer Recording ends.
- If the unit is in DVD mode when the VCR timer recording ends, the unit will not automatically power off.
- There is a short delay when a timer recording finishes to confirm the recorded program. If two timer recordings are set to record sequentially (one right after the other), the very beginning of the later program may not be recorded.
- You must press STOP (■) to stop the Timer Recording.

## Checking Timer Recording Details

Programming can be checked whenever the Recorder is turned on.

1. Press HOME and the Home menu appears.
2. Select [TV] > [Timer Record] and press ENTER.
3. Use ▲ / ▼ to select a program.
4. Press ENTER to edit the selected program. Timer Record menu appears.

## Canceling a Timer Recording

You can clear a timer setting anytime before the recording actually starts.

- Use ▲ / ▼ to select a program you want to erase on the Timer Recorder List, then press CLEAR and select [OK] than press ENTER.

### If you fail the AV1 Timer Recording

- Make sure IR Control Cable connection. (page 16)
- Set the [Set-Top Box Edit] options again then proceed the [Test] option. (page 22)
- If IR control is not activated even though you set again, the Recorder may not control your Set-Top Box according to the device's maker or status. Confirm recommended Set-Top Box on page 16 or contact your Set-Top Box provider.

## Timer Recording Troubleshooting

Even though the timer is set, the recorder will not record when:

- There is no disc (or tape) loaded.
- A non-recordable disc (or tape) is loaded.
- Disc Protect is set to [ON] in the Disc menu (see page 23).
- There are already 99 titles (DVD-RW, DVD-R, DVD-RAM), 49 titles (DVD+RW, DVD+R(DL)) recorded on the disc.

You cannot enter a timer program when:

- A recording is already underway.
- The time you're trying to set has already passed.
- There are already 16 timer programs set.

If two or more timer programs overlap:

- The earlier program takes priority.
- When the earlier program finishes, the later program starts.
- If two programs are set to start at exactly the same time, the program entered first takes priority.

If the disc is damaged, the recording may not complete successfully. In this case even though the Check field shows [Rec. OK], it may not be.

## Playing while you are recording **RAM**

You can start play from the beginning of the title while continuing to record it.

*While recording (in DVD mode)*

1. Press PLAY (▶).  
Start play of the title you are recording.
2. Press STOP (■) to return to the current recording screen.



OR

1. Press TIMESHIFT.  
The PIP(Picture-In-Picture) window appears on the screen as shown below. What is currently being recorded appears as a PIP and you will hear the playback audio.
  - You can switch between PIP window and Main window screen by pressing TIMESHIFT.



2. Press STOP (■) to return to the current recording screen.

### Notes:

- Play cannot be started until at least 30 seconds after recording starts. (MLP mode: after 1 minute)
- This function does not work in VCR Recording mode.
- This function can operate the DVD-RAM disc only.

## Dubbing from DVD to VCR

You can copy the contents of a DVD to a VHS tape using the DUBBING button.

1. Insert a blank VHS videotape into the VCR deck.
2. Insert the disc you wish to copy in the DVD deck and close the disc tray.
3. Select DVD mode by pressing DVD on the remote control or pressing DVD/VCR on the front panel.
4. Find the place on the DVD (or Disc) from which you want to start dubbing using the PLAY, FF, REW and PAUSE functions.  
For best results, pause playback at the point from which you want to record.
5. Press the DUBBING button.  
The Dubbing menu appears.



6. Use ▲ / ▼ / ◀ / ▶ to select the desired Record Mode: SP or SLP (3 times SP).
7. Select [Dubbing] then press ENTER or DUBBING to start copying.
8. To stop dubbing at any other time, press STOP (■).  
You must stop the dubbing process manually when the DVD movie ends, or the unit may replay and record over and over again.

### Note:

If the DVD (or Discs) you are attempting to copy is copy protected, you will not be able to copy the disc. It is not permitted to copy Macrovision encoded DVDs (or Discs). [Copy-protected. Cannot record.] is displayed on the TV screen.

### Tip:

If you press PAUSE during Dubbing mode, both the DVD and VCR decks go into Pause mode and the DUBBING button blinks on the front panel. While in Pause mode, you can adjust the DVD playback position using PLAY, REW, FF, PAUSE/STEP, etc. The VCR deck will remain in Pause mode. To resume Dubbing, press the DUBBING button twice.

## Dubbing from VCR to DVD

You can copy the contents of a VHS tape to a DVD using the DUBBING button. This allows you to archive your old VHS tapes to DVD.

1. Insert a blank DVD disc in the DVD deck and close the disc tray.
2. Insert the VHS video tape you wish to copy into the VCR deck.
3. Select VCR mode by pressing VCR on the remote control or pressing DVD/VCR on the front panel.
4. Find the place on the VHS tape from which you want to start dubbing using the PLAY, FF, REW and PAUSE functions. For best results, pause playback at the point from which you want to record.
5. Press the DUBBING button.  
The Dubbing menu appears.



6. Use ▲ / ▼ / ◀ / ▶ to select the desired Record Mode: XP, SP, LP, EP or MLP.
7. Select [Dubbing] then press ENTER or DUBBING to start copying.
8. To stop dubbing at any other time, press STOP (■).  
Dubbing will stop automatically when the VHS tape ends.

### Note:

If the VHS video tape you are attempting to copy is copy protected, you will not be able to copy the tape. It is not permitted to copy Macrovision encoded tapes.

### Tip:

If you press PAUSE during Dubbing mode, both the DVD and VCR decks go into Pause mode and the DUBBING button blinks on the front panel. While in Pause mode, you can adjust the VCR playback position using PLAY, REW, FF, PAUSE/STEP, etc. The DVD deck will remain in Pause mode. To resume Dubbing, press the DUBBING button twice.

## Recording from DV Input

### Before DV dubbing

You can connect a DV-equipped camcorder to this recorder using a single DV cable for input and output of audio, video, data and control signals.

- This recorder is only compatible with DV-format (DVC-SD, DV25) camcorders. Digital satellite tuners and Digital VHS video recorders are not compatible.
- You cannot connect more than one DV camcorder at a time to this recorder.
- You cannot control this recorder from external equipment connected via the DV IN jack (including two recorders).
- It may not always be possible to control the connected camcorder via the DV IN jack.
- Digital camcorders can usually record audio as stereo 16-bit/48kHz, or twin stereo tracks of 12-bit/32kHz. This recorder can only record one stereo audio track. Set [DV Record Audio] option to Audio 1 or Audio 2 as required (see page 21).
- Audio input to the DV IN jack should be 32 or 48kHz (not 44.1kHz).
- Picture disturbance on the recording may occur if the source component pauses playback or plays an unrecorded section of tape, or if the power fails in the source component, or the DV cable becomes disconnected.

### Recording from a Digital Camcorder

You can record from a digital camcorder connected to the DV IN jack on the front panel of this recorder.

Using the recorder's remote, you can control both the camcorder and this recorder.

Before recording, make sure that the audio input for the DV IN jack is set up (see page 21).

#### **Tips:**

- The source signal must be DVC-SD format.
- Some camcorders cannot be controlled using this recorder's remote.
- If you connect a second recorder using a DV cable, you cannot control the second DVD from this one.
- You cannot control this unit remotely from a component connected to the DV IN jack.
- You cannot record date and time information from a DV cassette.
- Disconnecting the DV cable while recording a contents of the connected digital camcorder may result in malfunction.

1. Make sure your digital camcorder is connected to the front panel DV IN jack. See page 15.
2. Press AV/INPUT repeatedly to select the DV input.
3. Find the place on the camcorder tape that you want to the recording to start from.  
For best results, pause playback at the point from which you want to record.
  - Depending on your camcorder, you can use this recorder's remote to control the camcorder using the STOP, PLAY, BACKWARD, FORWARD and PAUSE functions.
4. Press ● REC once to start recording.
  - Recording is automatically stopped if the recorder detects no signal.
  - You can pause or stop the recording by pressing PAUSE/STEP (II) or STOP (■). You cannot control the camcorder from this Remote Control during recording.
  - In Video mode, the final frame of the recording may remain displayed on screen for a while after recording stops.

### Troubleshooting

If you cannot get a picture and/or audio through the DV IN jack, check the bullet points:

- Make sure the DV cable is properly connected.
- Try switching off the connected equipment then switch back on.
- Try switching the audio input.

#### **Note:**

Depending on the connected camcorder, you may not be able to control it using the Remote Control supplied with this recorder.

# Editing

## Title List and Chapter List Menu Overview

Using the Title List menu you can edit video content. The editing features available in the Title List menu depend on whether you are editing video on DVD, and whether you're editing Original content, or a Playlist.

There are two ways to edit VR mode DVD-RW discs. You can directly edit the Original content of the disc, or you can create and edit a Playlist. The Playlist doesn't actually change any of the content on the disc, but just controls how the content is played back.

- Press DISC MENU/LIST to display the TITLE LIST menu. Playback should be stopped when you do this.
  - When selecting titles, use the ▲ / ▼ buttons to display the previous/next page if there are more than six titles.
  - If you are editing a VR mode disc, press DISC MENU/LIST to switch between Original and Playlist menu.
  - On the left side of the screen are the menu options. The main part of the screen shows thumbnails of the titles (or chapter) on the DVD. You can change these thumbnails using the THUMBNAIL button. (see [Changing Title Thumbnails] on page 41.)
  - Press DISPLAY to display the information of selected title on the Title List menu.
  - After selecting a title or chapter on the Title List or Chapter List menu, then press ENTER. The menu options on the left side of the menu. Use ▲ / ▼ to select a option then press ENTER to confirm your selection.
- To exit the TITLE LIST menu, press RETURN (↵) repeatedly.

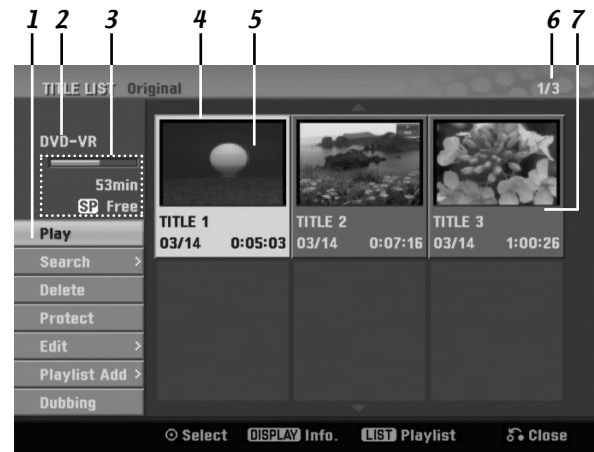

- Menu options: To display menu option, select a title or chapter then press ENTER. The options displayed differ depending on the disc type.
  - [Play] Start playback of the selected title or chapter. The hidden titles and chapters on the DVD+R/RW cannot be play back.
  - [Search]
    - [Chapter] ; Displays Chapter List of the Title.
    - [Time] ; Search time for you want start point of the title (page 44).
  - [Delete] Deletes the title or chapter. (page 43)
  - [Move] Moves chapter position on [Chapter List - Playlist] menu (page 45).
  - [Protect] Protects accidental recording, editing or deleting of the title.(page 45)
  - [Edit] Edits or Deletes a part of the title.
    - [Title Name] Edits the title name. (page 44).
    - [Delete Part] Deletes a part of the Title (page 43).
    - [Divide] Divides a title into two (page 46).
    - [Hide (Show)] Hides (or Shows) the selected title or chapter. (page 45)
  - [Playlist Add] Adds the title or chapter to the Playlist. (page 42)
  - [Dubbing] Dubs the title to VCR (page 38).
  - [Title] Displays Title List of the chapter.
  - [Combine] Combines two chapters into one (page 46).
  - [Full Play] Starts playback of the selected title including the hidden chapters.
- Current media.
- Indicates the record mode, free space, and elapsed time progress bar.
- Currently selected title.
- Thumbnail.
- Shows the selected title number and total number of titles.
- Shows the title name, recorded date, and recording length.



## VR Mode: Original and Playlist Editing

### Titles, Chapters and Parts

Titles in the disc's original content may contain one or more chapters. When you insert a disc's title into the Playlist, all the chapters within that title also appear. In other words, chapters in the Playlist behave exactly as chapters on a DVD-Video disc do. Parts are sections of Original or Playlist titles. From the Original and Playlist menu you can add or delete parts. Adding a chapter or title to the Playlist creates a new title made up of a section (ie., chapter) of an Original title. Deleting a part removes part of a title from the Original or Playlist menu.

#### **Caution:**

- When editing using the Delete, Add and Move functions, the start and end frames may not be exactly as set in the start and end point display.
- During Playlist playback, you may notice a momentary pause between edits. This is not a malfunction.

### Is editing a DVD like editing a video tape?

No. When you edit a video tape you need one video deck to play the original tape and another to record the edits. With DVD, you edit by making a 'Playlist' of what to play and when to play it. On playback, the Recorder plays the disc according to the Playlist.

### About word 'Original' and 'Playlist'

**-RW<sub>VR</sub> RAM**

Throughout this manual, you will often see the words Original and Playlist to refer to the actual content and the edited version.

- **Original:** content refers to what's actually recorded on the disc.
- **Playlist:** content refers to the edited version of the disc — how the Original content is to be played.

## Adding Chapter Markers

**Chapter** **-RW<sub>VR</sub>** **+RW** **+R** **RAM**

You can create chapters within a title by inserting chapter marks at the desired points.

#### **Note:**

Chapter markers are inserted at regular intervals automatically. You can change this interval from the Initial Setup menu (see [Auto Chapter] on page 21).

During recording or playing back, at the point you want to start a new chapter, press **CHP. ADD**. A chapter marker icon appears on the TV screen.

## Changing the Title Thumbnails

**Thumbnail** **-RW<sub>VR</sub>** **+RW** **+R** **RAM**

Each title displayed in the Title List menu is represented by a thumbnail picture taken from the start of that title or chapter.

If you prefer, select a different still picture from within a title.

Press **THUMBNAIL** to make the currently displayed picture the one that appears in the Title List menu. The still picture that you choose appears in both the Original or Playlist menu.

#### **Tip** **-RW<sub>VR</sub> RAM**:

You can also change the thumbnail picture of the title on the Chapter List menu. Select a chapter on the Chapter List menu then press **THUMBNAIL**. The thumbnail picture of the title that includes the chapter is changed.

## Making a New Playlist

**-RW/VR** **RAM**

Use this function to add an Original title or chapter to the Playlist. When you do this, the whole title or chapter are put into the Playlist (you can delete bits you don't need later - see [Deleting an Original or Playlist title/chapter] on page 43).

The title appears in the Playlist complete with the chapter markers that appear in the Original. However, if you add more chapter markers to the Original later, these are not automatically copied over into the Playlist title.

You can add up to 999 chapters to one disc.

1. Choose a title or chapter on the [TITLE LIST-Original] menu or [Chapter List-Original] menu to put into the Playlist, then press ENTER. The menu options appears on the left side of the screen.
2. Use ▲ / ▼ to select [Playlist Add] option then press ►.



3. Select [New Playlist] then press ENTER. The new title appears in the updated Playlist. All chapters of the title are added to the Playlist.



## Adding Additional Title / Chapters to the Playlist

**-RW/VR** **RAM**

You can add an Original title or chapter to add to a Playlist title even if it is already registered.

1. Choose a title or chapter on the [TITLE LIST-Original] menu or [Chapter List-Original] menu to put into the Playlist, then press ENTER. The menu options appears on the left side of the screen.
2. Use ▲ / ▼ to select [Playlist Add] from menu options then press ►.



3. Choose a Title List-Playlist that is already registered to insert a title or chapter, then press ENTER.
4. Repeat steps 1-3 to add additional title or chapter on the Playlist. You can view the added chapters on the [Chapter List-Playlist] menu.



5. Press RETURN (↵) to exit, or DISC MENU/LIST to go back to the [Title List-Original] menu.

## Deleting an Original or Playlist Title/Chapter

When you erase a title or chapter from the Playlist menu, you only remove it from the Playlist; the title/chapter remains in the Original menu.

If you choose to delete a title or chapter from the Original (title/chapter) menu, the title or chapter is actually deleted from the disc and the remaining time available for recording increases. Titles/chapters deleted from the Original are also removed from the Playlist.

### Note:

It may not be possible to delete chapters that are less than 3 seconds long.

1. Use ◀ / ▶ / ▲ / ▼ to choose a chapter or title you want to delete on the [TITLE LIST] or [Chapter List] menu then press ENTER. The menu options appears on the left side of the screen.
2. Select [Delete] option from the options on the menu.

Example: Title List (DVD-VR)



3. Press ENTER to confirm. The confirm message for deleting will appear.
4. Use ◀ / ▶ to select [OK] then press ENTER. The selected chapter or title is deleted. After pressing ENTER, the new, updated menu is displayed.
5. Repeat steps 1 - 4 to continue to delete from the menu.
6. Press RETURN (↵) repeatedly to exit the menu.

### Notes:

- When DVD+RW recording, the deleted title's name is changed to [Deleted Title].
- If more than two titles are repeatedly deleted, the titles are combined into one.
- When you are deleting a title or chapter, only the last one on DVD+R/RW increases remaining recording time.

## Deleting a Part **-RWVR** **RAM**

You can delete a part which you do not want in the title.

1. Use ◀ / ▶ / ▲ / ▼ to choose a title you want to delete on the Title List menu then press ENTER. The options appears on the left side of the menu.
2. Select [Edit] > [Delete Part] option then press ENTER. [Edit] menu appears on the TV screen.

Example: Edit (Delete Part) (DVD-VR)

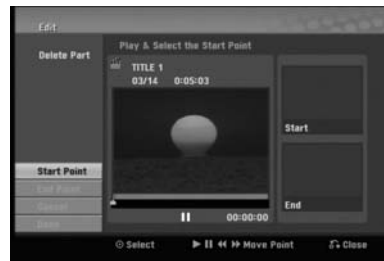

3. Use play, pause step, search and slow-motion to find the starting point.
4. Press ENTER at the starting point of the section you want to delete. [End Point] icon is highlighted. The part is indicated on the Progress Bar.
5. Use play, pause step, search and slow-motion to find the ending point.
6. Press ENTER at the ending point of the section you want to delete. You can cancel the selected point, use ▲ / ▼ to select [Cancel] icon then press ENTER.
7. If you finish to edit, select [Done] icon then press ENTER. The confirm message for deleting will appear. Use ◀ / ▶ to select [OK] then press ENTER. The selected part is deleted from the title and Title List menu appears.

### Notes:

- It may not be possible to delete parts that are less than 5 seconds long.
- If you select [Cancel] then press ENTER, the Recorder will go to previous option and into Pause mode.

## Naming a Title

You can name the titles.

1. Choose the title you want to name on the Title List menu, then press ENTER.  
The menu options appears on the left side of the menu.
2. Use ▲/▼ to select [Edit] > [Title Name] option then press ENTER.  
Keyboard menu appears.



3. Enter a name for the title. Use ◀/▶/▲/▼ to select a character then press ENTER to confirm your selection.
  - **Language:** Selects a keyboard type.
  - **Space:** Inserts a space at the cursor position.
  - **Delete:** Deletes the character to the left of the cursor position.
  - **◀ / ▶:** Moves the cursor left or right.
  - **OK:** Confirms the name you have entered.
  - **Cancel:** Deletes all characters and exits the Keyboard menu.

### Remote Control buttons for entering a name

- **PLAY (▶):** Inserts a space at the cursor position.
  - **PAUSE/STEP (⏸):** Deletes the character to the right of the cursor position.
  - **SKIP (◀◀ / ▶▶):** Moves the cursor left or right.
  - **STOP (■), CLEAR:** Deletes the character to the left of the cursor position.
  - **0-9:** Enters the character corresponding to the selected column.
  - **DISC MENU/LIST, DISPLAY:** Switches the keyboard type.
4. Choose [OK] then press ENTER to fix the name and return to the previous menu screen.
  5. Press RETURN (↵) repeatedly to exit the menu.

### Notes:

- Names can be up to 32 characters long.
- For discs formatted on a different recorder, you will see only a limited character set.
- When recording on DVD-R, DVD-RW or DVD+R discs, the entered name is displayed on the DVD player only after finalization.

## Time Search

You can select start point of the title.

1. Use ◀/▶/▲/▼ to choose a title on the TITLE LIST menu then press ENTER.  
The options appears on the left side of the menu.
2. Select [Search] > [Time] option then press ENTER.  
[Time] menu appears on the TV screen.

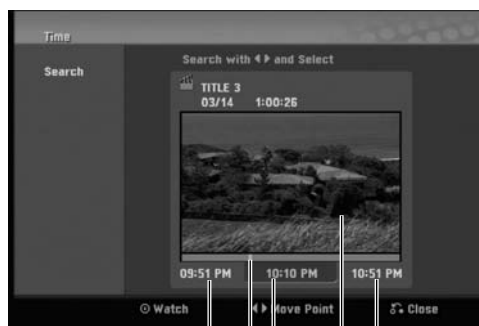

3. Use ◀/▶ to find the point you want to start.  
The point increase 1 minute step.  
If you press and hold ◀/▶ then the point increase 5 minute step.
4. Press ENTER to start selected point.

## Moving a Playlist Chapter

**-RW/VR** **RAM**

Use this function to re-arrange the playing order of Playlist chapters on the Chapter List-Playlist menu.

### Note:

This function is not available if there is only one chapter.

1. Select a chapter on the Chapter List-Playlist menu.
2. Press ENTER.  
The menu options appears on the left side of the menu.
3. Use ▲ / ▼ to select [Move] option from Playlist options then press ENTER.



4. Use ◀ / ▶ / ▲ / ▼ to choose the place you want to move the chapter then press ENTER.  
After pressing ENTER, the updated menu is displayed.

## Hide a Chapter/Title

**+RW** **+R**

You can skip playing chapters or titles without deleting from the disc.

1. Use ▲ ▼ ◀ ▶ to choose a chapter or title you want to hide on the [TITLE LIST] or [Chapter List] menu, then press ENTER.  
Options appear on the left side of the screen.
2. Select [Edit] > [Hide] option.

Example: Title List (DVD+RW)



3. Press ENTER to confirm.  
The chapter's or title's thumbnail will dim.

### Tip:

If you select a hidden chapter or title on the TITLE LIST or Chapter List menu, you can 'show' it by choosing [Show] option on the menu. After doing that, you are able to see the chapter or title.

## Protect a Title

**+RW** **+R** **-RW/VR** **RAM**

Use this function to protect against accidental recording, editing or deleting of the title.

1. Press DISC MENU/LIST to display the [TITLE LIST] menu.
2. Use ▲ ▼ ◀ ▶ to choose a title you want to protect then press ENTER.  
Options appear on the left side of the screen.
3. Select [Protect] from the options.

Example: Title List (DVD-VR)



4. Press ENTER to confirm.  
The lock mark will appear on the title's thumbnail.

### Tip:

If you select a title that has already been protected on the Title List menu, you can 'unprotect' it by choosing [Unprotect] option from the Title List menu options. After doing that, you can edit and delete the title.

## Divide One Title Into Two

**+RW**

Use this command to split a title up into two new titles.

1. On the Title List menu, select a title you want to divide then press ENTER.  
The menu options appears on the left side of the screen.
2. Select [Edit] > [Divide] option.  
Example: Title List (DVD+RW)



3. Press ENTER.  
[Edit (Divide)] menu appears.

Current picture

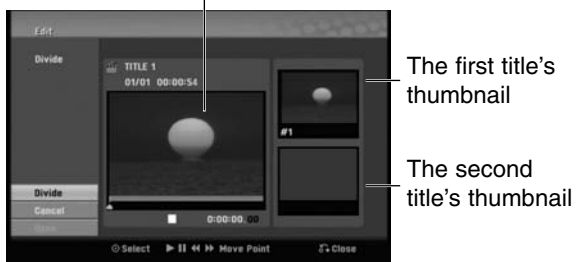

4. Use play, pause step, search and slow-motion to find the point you want to divide the title.
5. Select [Divide] option then press ENTER at the point.  
To reset the point, select [Cancel] option then press ENTER. Repeat from step 4.
6. Choose [Done] option then press ENTER to fix the dividing point.  
The title is divided into two new titles. It take up to 4 minutes to divide.

### Note:

The diving point may not be selected if the point is less than 3 seconds long.

## Combining Two Chapters Into One

**-RW/VR +RW +R RAM**

Use this function to combine two adjacent chapters into one.

1. On the Chapter List menu, select the second chapter of the two chapters you want to combine then press ENTER  
The menu options appears on the left side of the screen.
2. Use ▲ / ▼ to select [Combine] option.  
The combine indicator appears between the two chapters you want to combine.  
Example: Title List (DVD-VR)



3. Press ENTER to combine the chapters.
4. Repeat steps 1 - 3 to continue to combine from the menu.
5. Press RETURN (↵) repeatedly to exit the menu.

### Notes:

This function cannot operate listed as below;

- If there is only one chapter within the title.
- If you select first chapter.
- If two chapters created by erasing a part from an original title.
- If two chapters created from different titles.
- If two chapters created by moving an order from an original title.

## Overwriting Recording **+RW**

To overwrite a new video recording on a previously recorded title, follow these steps. This feature is not available for DVD+Rs, that always record at the end of the Disc.

1. Select input source you want to record (AV1-2).
2. Press DISC MENU/LIST to display the TITLE LIST menu.



3. Use ▲▼◀▶ to choose a title you want to overwrite.
4. Press ● REC to start overwrite recording. Overwrite recording starts from the start point of the title.
5. Press STOP (■) to stop the overwrite recording. The new title is created and updated menu is displayed.

### Notes:

- This function is not available for a protected title.
- **If you overwrite the longer recording than the current title on the fully recorded disc, the next title is overwritten.**
- **If next title is protected, the overwriting stops at the starting point of the title.**

## Viewing Title List menu displayed on other DVD Recorders or Players

**+RW +R**

You can view the Title List menu displayed on the other DVD player that is capable of playing DVD+RW or DVD+R discs.

1. Insert DVD+R or DVD+RW disc recorded already.

2. On DVD mode, press TITLE in Play mode or Stop mode.  
Title List menu will appear as shown below.



3. To play back a title, select the title you want then press ENTER or PLAY (▶).

### Tip:

You can remove the Title List menu by pressing STOP (■).

## Playing Your Recordings on Other DVD Players (Finalizing a Disc)

Most regular DVD players can play finalized discs recorded in Video mode, finalized DVD+R or DVD+RWs. A small number of players can also play DVD-RW discs recorded in VR mode, finalized or not. Check the manual that came with the other player to check what formats of discs it will play.

Finalizing 'fixes' the recordings and editings in place so that the disc can be played on a regular DVD player or computer equipped with a suitable DVD-ROM drive.

Finalizing a Video mode disc creates a menu screen for navigating the disc. The menu can be accessed by pressing DISC MENU/LIST or TITLE.

**To finalize a disc, refer to [Finalize] on page 23.**

### Notes:

- Unfinalized DVD+RW is playable on regular DVD players.
- The edited contents of a DVD+RW (DL) disc is compatible on regular DVD players only after finalization.
- Any edited contents of the DVD+R disc are not compatible on regular DVD players. (Hide, chapter combine, added chapter mark, etc.)
- How long finalization takes depends on the type of disc, how much is recorded on the disc, and the number of titles on the disc.
- DVD+R DL disc can take up to 30 minutes to finalize.

# Reference

## Controlling Your TV with the Supplied Multi-brand Remote Control

You can control the sound level, input source, and power switch of your LG TV with the supplied Multi-brand Remote Control.

You can control your TV using the buttons below.

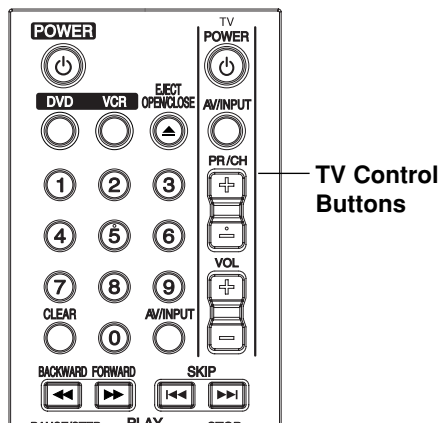

| By pressing | You can  |
|-------------|--|
| POWER       | Turn the TV on or off.   |
| AV/INPUT    | Switch the TV's input source between the TV and other input sources. |
| PR/CH +/-   | Scans up or down through memorized channels.                         |
| VOL +/-     | Adjust the volume of the TV.   |

### Note:

Depending on the unit being connected, you may not be able to control your TV using some of the buttons.

## Controlling other TVs with the Multi-brand Remote Control

You can control the sound level, input source, and power switch of non-LG TVs as well. If your TV is listed in the table below, set the appropriate manufacturer code.

1. While holding down TV POWER button, press the number buttons to select the manufacturer code for your TV (Refer to table on the right column).
2. Release TV POWER button.

### Code numbers of controllable TVs

If more than one code number is listed, try entering them one at a time until you find the one that works with your TV.

| Manufacturer  | Code Number    |
|---------------|----------------|
| LG / GoldStar | 1 (Default), 2 |
| Zenith        | 1, 3, 4        |
| Samsung       | 6, 7           |
| Sony          | 8, 9           |
| Hitachi       | 4              |

### Notes:

- Depending on your TV, some or all buttons may not function on the TV, even after entering the correct manufacturer code.
- If you enter a new code number, the code number previously entered will be erased.
- When you replace the batteries of the remote, the code number you have set may be reset to the default setting. Set the appropriate code number again.



## Language Code List

Use this list to input your desired language for the following initial settings: Disc Audio, Disc Subtitle, Disc Menu.

| Language        | Code | Language         | Code | Language       | Code | Language   | Code |
|-----------------|------|------------------|------|----------------|------|------------|------|
| Abkhazian       | 6566 | Fiji             | 7074 | Lingala        | 7678 | Singhalese | 8373 |
| Afar            | 6565 | Finnish          | 7073 | Lithuanian     | 7684 | Slovak     | 8375 |
| Afrikaans       | 6570 | French           | 7082 | Macedonian     | 7775 | Slovenian  | 8376 |
| Albanian        | 8381 | Frisian          | 7089 | Malagasy       | 7771 | Somali     | 8379 |
| Ameharic        | 6577 | Galician         | 7176 | Malay          | 7783 | Spanish    | 6983 |
| Arabic          | 6582 | Georgian         | 7565 | Malayalam      | 7776 | Sudanese   | 8385 |
| Armenian        | 7289 | German           | 6869 | Maltese        | 7784 | Swahili    | 8387 |
| Assamese        | 6583 | Greek            | 6976 | Maori          | 7773 | Swedish    | 8386 |
| Aymara          | 6588 | Greenlandic      | 7576 | Marathi        | 7782 | Tagalog    | 8476 |
| Azerbaijani     | 6590 | Guarani          | 7178 | Moldavian      | 7779 | Tajik      | 8471 |
| Bashkir         | 6665 | Gujarati         | 7185 | Mongolian      | 7778 | Tamil      | 8465 |
| Basque          | 6985 | Hausa            | 7265 | Nauru          | 7865 | Tatar      | 8484 |
| Bengali; Bangla | 6678 | Hebrew           | 7387 | Nepali         | 7869 | Telugu     | 8469 |
| Bhutani         | 6890 | Hindi            | 7273 | Norwegian      | 7879 | Thai       | 8472 |
| Bihari          | 6672 | Hungarian        | 7285 | Oriya          | 7982 | Tibetan    | 6679 |
| Breton          | 6682 | Icelandic        | 7383 | Panjabi        | 8065 | Tigrinya   | 8473 |
| Bulgarian       | 6671 | Indonesian       | 7378 | Pashto, Pushto | 8083 | Tonga      | 8479 |
| Burmese         | 7789 | Interlingua      | 7365 | Persian        | 7065 | Turkish    | 8482 |
| Byelorussian    | 6669 | Irish            | 7165 | Polish         | 8076 | Turkmen    | 8475 |
| Cambodian       | 7577 | Italian          | 7384 | Portuguese     | 8084 | Twi        | 8487 |
| Catalan         | 6765 | Japanese         | 7465 | Quechua        | 8185 | Ukrainian  | 8575 |
| Chinese         | 9072 | Javanese         | 7487 | Rhaeto-Romance | 8277 | Urdu       | 8582 |
| Corsican        | 6779 | Kannada          | 7578 | Rumanian       | 8279 | Uzbek      | 8590 |
| Croatian        | 7282 | Kashmiri         | 7583 | Russian        | 8285 | Vietnamese | 8673 |
| Czech           | 6783 | Kazakh           | 7575 | Samoan         | 8377 | Volapük    | 8679 |
| Danish          | 6865 | Kirghiz          | 7589 | Sanskrit       | 8365 | Welsh      | 6789 |
| Dutch           | 7876 | Korean           | 7579 | Scots Gaelic   | 7168 | Wolof      | 8779 |
| English         | 6978 | Kurdish          | 7585 | Serbian        | 8382 | Xhosa      | 8872 |
| Esperanto       | 6979 | Laothian         | 7679 | Serbo-Croatian | 8372 | Yiddish    | 7473 |
| Estonian        | 6984 | Latin            | 7665 | Shona          | 8378 | Yoruba     | 8979 |
| Faroese         | 7079 | Latvian, Lettish | 7686 | Sindhi         | 8368 | Zulu       | 9085 |

## Area Code List

Choose a area code from this list.

| Area           | Code | Area                       | Code | Area                 | Code | Area            | Code |
|----------------|------|----------------------------|------|----------------------|------|-----------------|------|
| Afghanistan    | AF   | Ethiopia                   | ET   | Malaysia             | MY   | Saudi Arabia    | SA   |
| Argentina      | AR   | Fiji                       | FJ   | Maldives             | MV   | Senegal         | SN   |
| Australia      | AU   | Finland                    | FI   | Mexico               | MX   | Singapore       | SG   |
| Austria        | AT   | France                     | FR   | Monaco               | MC   | Slovak Republic | SK   |
| Belgium        | BE   | Germany                    | DE   | Mongolia             | MN   | Slovenia        | SI   |
| Bhutan         | BT   | Great Britain              | GB   | Morocco              | MA   | South Africa    | ZA   |
| Bolivia        | BO   | Greece                     | GR   | Nepal                | NP   | South Korea     | KR   |
| Brazil         | BR   | Greenland                  | GL   | Netherlands          | NL   | Spain           | ES   |
| Cambodia       | KH   | Heard and McDonald Islands | HM   | Netherlands Antilles | AN   | Sri Lanka       | LK   |
| Canada         | CA   | Hong Kong                  | HK   | New Zealand          | NZ   | Sweden          | SE   |
| Chile          | CL   | Hungary                    | HU   | Nigeria              | NG   | Switzerland     | CH   |
| China          | CN   | India                      | IN   | Norway               | NO   | Taiwan          | TW   |
| Colombia       | CO   | Indonesia                  | ID   | Oman                 | OM   | Thailand        | TH   |
| Congo          | CG   | Israel                     | IL   | Pakistan             | PK   | Turkey          | TR   |
| Costa Rica     | CR   | Italy                      | IT   | Panama               | PA   | Uganda          | UG   |
| Croatia        | HR   | Jamaica                    | JM   | Paraguay             | PY   | Ukraine         | UA   |
| Czech Republic | CZ   | Japan                      | JP   | Philippines          | PH   | United States   | US   |
| Denmark        | DK   | Kenya                      | KE   | Poland               | PL   | Uruguay         | UY   |
| Ecuador        | EC   | Kuwait                     | KW   | Portugal             | PT   | Uzbekistan      | UZ   |
| Egypt          | EG   | Libya                      | LY   | Romania              | RO   | Vietnam         | VN   |
| El Salvador    | SV   | Luxembourg                 | LU   | Russian Federation   | RU   | Zimbabwe        | ZW   |

## Troubleshooting

Check the following guide for the possible cause of a problem before contacting service.

| Symptom                                   | Cause  | Correction  |
|---|--|---|
| No power.                                 | <ul style="list-style-type: none"> <li>The power cord is disconnected.</li> </ul>  | <ul style="list-style-type: none"> <li>Plug the power cord into the wall outlet securely.</li> </ul>  |
| Abnormal or no picture.                   | <ul style="list-style-type: none"> <li>The TV is not set to receive Recorder signal output.</li> </ul>                                       | <ul style="list-style-type: none"> <li>Select the appropriate video input mode on the TV so the picture from the Recorder appears on the TV screen.</li> </ul>  |
|   | <ul style="list-style-type: none"> <li>The video cable is not connected securely.</li> </ul>   | <ul style="list-style-type: none"> <li>Connect the video cable into the jacks securely.</li> </ul>  |
|   | <ul style="list-style-type: none"> <li>Unit output setting and TV resolution capabilities mismatch.</li> </ul>                               | <ul style="list-style-type: none"> <li>Check TV capability.</li> <li>Check mode of connections (eg. S-Video, Components etc.).</li> <li>Check unit Resolution setting according to TV capability and mode of connection.</li> </ul> |
|   | <ul style="list-style-type: none"> <li>Wrong connection.</li> </ul>  | <ul style="list-style-type: none"> <li>Check the connection.</li> </ul>   |
| No sound.                                 | <ul style="list-style-type: none"> <li>The equipment connected with the audio cable is not set to receive Recorder signal output.</li> </ul> | <ul style="list-style-type: none"> <li>Select the correct input mode of the audio receiver so you can listen to the sound from the Recorder.</li> </ul>   |
|   | <ul style="list-style-type: none"> <li>The audio cables are not connected securely.</li> </ul>   | <ul style="list-style-type: none"> <li>Connect the audio cable into the jacks securely.</li> </ul>  |
|   | <ul style="list-style-type: none"> <li>The power of the equipment connected with the audio cable is turned off.</li> </ul>                   | <ul style="list-style-type: none"> <li>Turn on the equipment connected with the audio cable.</li> </ul>   |
|   | <ul style="list-style-type: none"> <li>The AUDIO options are set to the wrong position.</li> </ul>   | <ul style="list-style-type: none"> <li>Set the AUDIO options to the correct position.</li> </ul>  |
|   | <ul style="list-style-type: none"> <li>In HDMI mode, audio selection is not set to PCM.</li> </ul>   | <ul style="list-style-type: none"> <li>Change AUDIO setup to PCM mode.</li> </ul>   |
| The playback picture is poor.             | <ul style="list-style-type: none"> <li>The disc is dirty.</li> </ul>   | <ul style="list-style-type: none"> <li>Clean the disc.</li> </ul>   |
|   | <ul style="list-style-type: none"> <li>Tape heads are dirty.</li> </ul>  | <ul style="list-style-type: none"> <li>Clean video heads.</li> </ul>  |
|   | <ul style="list-style-type: none"> <li>Tape is a rental or was recorded on another VCR.</li> </ul>   | <ul style="list-style-type: none"> <li>Use TRK +/- for manual tracking adjustment while tape is playing.</li> </ul>   |
| Picture from external input is distorted. | <ul style="list-style-type: none"> <li>The video signal from the external component is copy-protected.</li> </ul>                            | <ul style="list-style-type: none"> <li>You cannot connect via the Recorder. Connect the component directly to your TV.</li> </ul>   |

| Symptom   | Cause   | Correction   |
|---|---|--|
| The Recorder does not start playback.   | <ul style="list-style-type: none"> <li>No disc is inserted.</li> <li>No tape is inserted.</li> </ul>                            | <ul style="list-style-type: none"> <li>Insert a disc or tape. (Check that the disc or tape indicator in the display window is lit.)</li> </ul> |
|   | <ul style="list-style-type: none"> <li>An unplayable disc is inserted.</li> </ul>   | <ul style="list-style-type: none"> <li>Insert a playable disc. (Check the disc type and Regional code.)</li> </ul>                             |
|   | <ul style="list-style-type: none"> <li>The disc is placed upside down.</li> </ul>   | <ul style="list-style-type: none"> <li>Place the disc with the playback side down.</li> </ul>  |
|   | <ul style="list-style-type: none"> <li>The disc is not placed within the guide.</li> </ul>                                      | <ul style="list-style-type: none"> <li>Place the disc on the disc tray correctly inside the guide.</li> </ul>                                  |
|   | <ul style="list-style-type: none"> <li>The disc is dirty.</li> </ul>  | <ul style="list-style-type: none"> <li>Clean the disc.</li> </ul>  |
|   | <ul style="list-style-type: none"> <li>The Rating level is set.</li> </ul>  | <ul style="list-style-type: none"> <li>Cancel the Rating function or change the rating level.</li> </ul>                                       |
| Video tape cannot be inserted.  | <ul style="list-style-type: none"> <li>Is the cassette compartment empty?</li> </ul>  | <ul style="list-style-type: none"> <li>Eject the tape in.</li> </ul>   |
| The Remote Control does not work properly.                                    | <ul style="list-style-type: none"> <li>There is an obstacle in the path of the Remote Control and this unit.</li> </ul>         | <ul style="list-style-type: none"> <li>Remove the obstacle.</li> </ul>   |
|   | <ul style="list-style-type: none"> <li>The batteries in the Remote Control are exhausted.</li> </ul>                            | <ul style="list-style-type: none"> <li>Replace the batteries with new ones.</li> </ul>   |
|   | <ul style="list-style-type: none"> <li>The Remote Control is not pointed at the remote sensor of the Recorder.</li> </ul>       | <ul style="list-style-type: none"> <li>Point the Remote Control at the remote sensor of the Recorder.</li> </ul>                               |
|   | <ul style="list-style-type: none"> <li>The Remote Control is too far from the Recorder.</li> </ul>                              | <ul style="list-style-type: none"> <li>Operate the Remote Control within 23ft (7m).</li> </ul>   |
|   | <ul style="list-style-type: none"> <li>This Remote Control use the same buttons for VCR and DVD functions (ex.PLAY).</li> </ul> | <ul style="list-style-type: none"> <li>When using a VCR, first press the VCR button. When using a DVD, first press the DVD button.</li> </ul>  |
| Camcorder image is not shown.   | <ul style="list-style-type: none"> <li>Camcorder is off.</li> </ul>   | <ul style="list-style-type: none"> <li>Turn camcorder on and operate properly.</li> </ul>  |
| Camcorder image via A/V input or DV IN to Recorder is not shown on TV screen. | <ul style="list-style-type: none"> <li>The recorder's source is incorrect.</li> </ul>   | <ul style="list-style-type: none"> <li>Use AV/INPUT to select input channel (AV1, AV2 or DV IN).</li> </ul>                                    |
| Timer recording is not possible.  | <ul style="list-style-type: none"> <li>Clock in record is not set to correct time.</li> </ul>                                   | <ul style="list-style-type: none"> <li>Set clock to correct time.</li> </ul>   |
|   | <ul style="list-style-type: none"> <li>Timer has been programmed incorrectly.</li> </ul>  | <ul style="list-style-type: none"> <li>Reprogram Timer.</li> </ul>   |
|   | <ul style="list-style-type: none"> <li>Ⓞ (TIMER Record) indicator light does not appear after programming timer.</li> </ul>     | <ul style="list-style-type: none"> <li>Reprogram Timer and turn the Recorder off to enable timer.</li> </ul>                                   |

| Symptom  | Cause  | Correction   |
|--|--|--|
| Can't play disc recorded on this Recorder on another DVD player. | • The disc was recorded in Video mode.   | • Finalize the disc; see page 23.  |
|  | • Some players will not play even a finalized disc recorded in Video mode.                       | • No solution.   |
|  | • The disc was recorded in VR mode.  | • The other player must be RW compatible in order to play it.                  |
|  | • Discs recorded with copy-once material cannot be played on other players.                      | • No solution.   |
| Cannot record or did not record successfully.                    | • The remaining blank space on the disc is insufficient.   | • Use another disc.  |
|  | • The source you are trying to record is copy-protected.   | • You cannot record the source.  |
|  | • When recording to a Video mode disc, programs that are copy-once protected cannot be recorded. | • Use a VR mode formatted disc for copy-once material.                         |
| Stereo Audio Record and/or Playback not present.                 | • Recorder A/V Out jacks are not connected to TV A/V In jacks.                                   | • Make A/V connections. Stereo is available only via A/V output from Recorder. |
|  | • Recorder Audio/Video Out is not selected for viewing at the TV.                                | • Select AUX or A/V source as TV input.  |

## Resetting the Recorder

If you observe any of the following symptoms...

- When the Recorder is plugged in, but the power will not turn on or off.
- When the display window is not working.
- When the Recorder does not operate normally.

You can reset the Recorder as follows:

- Press and hold the POWER button for more than five seconds. This will force the Recorder to power off. Press the POWER button again to turn the Recorder back on.
- Unplug the power cord and then plug the power cord again after more than five seconds.

## Specifications

### General

|                       |  |
|-----------------------|--|
| Power requirements    | AC 120V, 60 Hz   |
| Power consumption     | 24W  |
| Dimensions (approx.)  | 430 X 78.5 X 260 mm (16.9 x 3.1 x 10.2 inches) (w x h x d) |
| Net Weight (approx.)  | 5.8 kg (12.79 lbs)   |
| Operating temperature | 5°C to 35°C (41°F to 95°F)                                 |
| Operating humidity    | 5 % to 90 %  |
| Signal system         | NTSC   |

### Recording

|                  |  |
|------------------|--|
| Recording format | DVD VideoRecording, DVD-VIDEO  |
| Recordable discs | DVD-ReWritable, DVD-Recordable, DVD+ReWritable, DVD+Recordable (Double Layer), DVD-Random Access Memory DVD; Approx. 1 hour (XP mode), 2 hours (SP mode), 4 hours (LP mode), 6 hours (EP mode), 11 hours (MLP) |
| Recordable time  | DVD+R DL (8.5GB); Approx. 1.8 hour (XP mode), 3.6 hours (SP mode), 7.3 hours (LP mode), 9 hours (EP mode), 11 hours (MLP)<br>VCR; SP: 2 HOURS (T-120), SLP: 6 HOURS (T-120)/8 HOURS (T-160)                    |

### Video recording format

|                    |                      |
|--------------------|----------------------|
| Sampling frequency | 27MHz                |
| Compression format | MPEG 2 (VBR support) |

### Audio recording format

|                    |               |
|--------------------|---------------|
| Sampling frequency | 48kHz         |
| Compression format | Dolby Digital |

### VCR Specifications

|                       |   |
|-----------------------|---|
| Head system           | Four head helical scan azimuth system                 |
| Timer                 | 12-hour display type with AM, PM                      |
| Tape speed            | SP: 33.35 mm/sec, LP: 16.67 mm/sec, SLP: 11.12 mm/sec |
| Tape width            | 12.7 mm   |
| Rewind time           | About 180 seconds (T-120)                             |
| Frequency range       | 20Hz to 20kHz   |
| Signal-to-noise ratio | 43dB  |
| Dynamic range         | 88 dB   |
| Channel separation    | 60 dB   |

## DVD Specifications

|                       |  |
|-----------------------|--|
| Laser system          | Semiconductor laser, wavelength 650 nm               |
| Frequency response    | DVD (PCM 48 kHz): 8 Hz to 22 kHz, CD: 8 Hz to 20 kHz |
| Signal-to-noise ratio | More than 95dB                                       |
| Harmonic distortion   | Less than 0.008%                                     |
| Dynamic range         | More than 90 dB                                      |

## Inputs

|                  |   |
|------------------|---|
| VIDEO IN (AV1,2) | 1.0 Vp-p 75 ohms, sync negative, RCA jack x 2     |
| AUDIO IN (AV1,2) | - 6.0 dBm more than 47 kohms, RCA jack (L, R) x 2 |
| DV IN            | 4 pin (IEEE 1394 standard)                        |

## Outputs

|                              |   |
|------------------------------|---|
| VIDEO OUTPUT                 | 1 Vp-p 75 $\Omega$ , sync negative, RCA jack x 1  |
| S-VIDEO OUTPUT               | (Y) 1.0 V (p-p), 75 $\Omega$ , negative sync, Mini DIN 4-pin x 1<br>(C) 0.286 V (p-p) 75 $\Omega$               |
| COMPONENT OUTPUT             | (Y) 1.0 V (p-p), 75 $\Omega$ , negative sync, RCA jack x 1<br>(PB)/(PR) 0.7 V (p-p), 75 $\Omega$ , RCA jack x 2 |
| HDMI video/audio output      | 19 pin (HDMI standard, Type A)  |
| Audio output (digital audio) | 0.5 V (p-p), 75 $\Omega$ , RCA jack x 1   |
| Audio output (optical audio) | Optical connector x 1   |
| Audio output (analog audio)  | 1 kHz, -6 dBm, 600 $\Omega$ , RCA jack (L, R) x 2   |
| IR TRANSMITTER OUT           | 5 V (p-p)   |

## Accessory:

|                          |   |                              |   |
|--------------------------|---|------------------------------|---|
| Video cable . . . . .    | 1 | Audio cable (L, R) . . . . . | 1 |
| Remote Control . . . . . | 1 | IR control cable . . . . .   | 1 |
| Batteries . . . . .      | 2 |                              |   |

*Design and specifications are subject to change without notice.*



## LG Electronics, Inc. Limited Warranty - USA

This LG Electronics product, will be repaired or replaced, at LG's option, if it proves to be defective in material or workmanship, under normal use, during the warranty period ("Warranty Period") listed below, effective from the date ("Date of Purchase") of original consumer purchase of the product. This warranty is good only to the original purchaser of the product and effective only when used in the United States, excluding U.S. Territories.

|   |   |
|---|---|
| <b>WARRANTY PERIOD:</b><br><b>LABOR: 90 days</b> from the Date of Purchase.<br><br><b>PARTS: One Year</b> from the Date of Purchase.<br><br>* Parts replaced are warranted for the remaining portion of the original warranty period. | <b>HOW SERVICE IS HANDLED:</b><br><b>Call 1-800-243-0000</b> for instructions on getting the defective unit repaired or replaced.<br><br><b>Please retain dated sales receipt and your box</b> to return the unit to LG for repair or replacement.<br><br>Shipping both ways will be paid by LG during the Warranty Period. After the Warranty Period, you pay inbound shipping charges and LG pays return shipping charges.<br><br>Visit our website at: <a href="http://www.lgservice.com">http://www.lgservice.com</a> |
|---|---|

**THIS WARRANTY IS IN LIEU OF ANY OTHER WARRANTIES, EXPRESS OR IMPLIED, INCLUDING WITHOUT LIMITATION, ANY WARRANTY OF MERCHANTABILITY OR FITNESS FOR A PARTICULAR PURPOSE. TO THE EXTENT ANY IMPLIED WARRANTY IS REQUIRED BY LAW, IT IS LIMITED IN DURATION TO THE EXPRESS WARRANTY PERIOD ABOVE. LG ELECTRONICS WILL NOT BE LIABLE FOR ANY INCIDENTAL, CONSEQUENTIAL, INDIRECT, SPECIAL OR PUNITIVE DAMAGES OF ANY NATURE, EVEN IF ADVISED OF THE POSSIBILITY OF SUCH DAMAGES, INCLUDING WITHOUT LIMITATION, LOST REVENUES OR PROFITS, LOST OR CORRUPTED PROGRAMMING OR DATA, OR ANY OTHER DAMAGE WHETHER BASED IN CONTRACT, TORT OR OTHERWISE.** Some states do not allow the exclusion or limitation of incidental or consequential damages or limitation on how long an implied warranty lasts, so the above exclusion or limitation may not apply to you. This warranty gives you specific legal rights and you may also have other rights that may vary from state to state.

### THIS LIMITED WARRANTY DOES NOT APPLY TO:

- Damages or operating problems that result from shipping, installation, adjustment of user controls, calibration, maintenance or failure to maintain, or separate system components; and
- Damages or operating problems that result from normal wear and tear, misuse, abuse, operation outside environmental specifications or contrary to the requirements or precautions in the Operating Guide, accident, lightning strikes or other natural causes, unauthorized modification or alteration, incorrect electrical current or voltage, reception problem caused by inadequate home antenna or faulty antenna connections, computer software, institutional or commercial use, or other causes not arising out of defect in material or workmanship.

Therefore, the cost of repair or replacement of such defective product shall be borne by the consumer.

### CUSTOMER INTER-ACTIVE CENTER NUMBERS:

|  |   |
|--|---|
| <b>For nearest Authorized Service Center, Where to buy, Product Assistance, or Customer Assistance</b> | <b>Call 1-800-243-0000</b> (24 hours a day, 365 days per year) and select appropriate options from the menu.<br><br>Or visit our website at <a href="http://www.lgservice.com">http://www.lgservice.com</a> |
|--|---|

LG ELECTRONICS U.S.A., INC.  
1000 SYLVAN AVENUE  
ENGLEWOOD CLIFFS, NJ

P/N: MFL36995844  
Issue O  
Printed in Indonesia